

TECHNICAL MANUAL

DIRECT SUPPORT AND GENERAL SUPPORT

MAINTENANCE REPAIR PARTS

AND SPECIAL TOOLS LISTS

FOR

RECEIVER-TRANSMITTER,

RADIO RT-718/FRC-93

(NSN 5820-00-616-3973)

TECHNICAL MANUAL }
 NO.11-5820-554-34P-3 }

HEADQUARTERS
 DEPARTMENT OF THE ARMY
 WASHINGTON, DC, 23 February 1978

DIRECT SUPPORT AND GENERAL SUPPORT MAINTENANCE

REPAIR PARTS AND SPECIAL TOOLS LISTS

FOR

RECEIVER-TRANSMITTER, RADIO RT-718/FRC-93

(NSN 5820-00-616-3973)

Current as of 15 April 1977

REPORTING OF ERRORS

You can improve this manual by recommending improvements using DA Form 2028-2 (Test) located in the back of the manual. Simply tear out the self-addressed form, fill it out as shown on the sample, fold it where shown, and drop it in the mail.

If there are no blank DA Forms 2028-2 (Test) in the back of your manual, use the standard DA Form 2028 (Recommended Changes to Publications and Blank Forms) and forward to Commander, US Army Electronics Command, ATTN: DRSE-MA-Q, Fort Monmouth, NJ 07703.

In either case a reply will be furnished direct to you.

TABLE OF CONTENTS

		Page	Illus Figure
SECTION	I. Introduction	1	
	II. Repair parts list	5	
Group	00 Receiver-Transmitter, Radio RT-718/FRC-93.....	5	1
	01 Cabinet, receiver	5	1
	02 Chassis, subassembly.....	27	2
	0201 Oscillator, radio frequency.....	39	3
	99 Bulk materials	39	
SECTION	III. Special tools list not applicable}		
	IV. National stock number and part number index.....	41	

Section I. INTRODUCTION

1. Scope

This manual lists repair parts required for the performance of direct support maintenance of the RT-7 18/FRC-93.

2. General

This Repair Parts and Special Tools List is divided into the following sections:

a. Section II. Repair Parts List. A list of repair parts authorized for use in the performance of maintenance. The list also includes parts which must be removed for replacement of the authorized parts. Parts lists are composed of functional groups in ascending numerical sequence, with the parts in each group listed in figure and item number sequence. Bulk materials are listed in NSN sequence.

b. Section III. Special Tools List. Not applicable.

c. Section IV. National Stock Number and Part Number Index. A list, in ascending numerical sequence, of all National stock numbers appearing in the listing, followed by a list, in alphanumeric sequence of all part numbers appearing in the listings. National stock numbers and part numbers are cross-referenced to each illustration figure and item number appearance.

3. Explanation of Columns

The following provides an explanation of columns found in the tabular listings:

a. Illustration. This column is divided, as follows:

(1) *Figure number.* Indicates the figure number of the illustration in which the item is shown.

(2) *Item number.* The number used to identify each item called out in the illustration.

b. Source, Maintenance, and Recoverability Codes (SMR).

(1) *Source code.* Source codes are assigned to support items to indicate the number of acquiring support items for maintenance, repair, or overhaul of end items. Source codes are entered in the first and second positions of the Uniform SMR Code format as follows:

<i>Code</i>	<i>Definition</i>
PA-Item procured and stocked for known usage anticipated or XA-Item is not procured or stocked because the requirements for the item will result in the replacement of the next higher assembly.	
XD-A support item that is not stocked. When required, item will be procured through normal supply channels.	

NOTE

Cannibalization any items source coded above, except those coded XA, XD, and aircraft support items as restricted by AR 700-42.or salvage may be used as source of supply for

(2) *Maintenance code.* Maintenance codes are assigned to indicate the levels of maintenance authorized to USE and REPAIR support items.

The maintenance codes are entered in the third and fourth positions of the Uniform SMR Code format as follows:

(a) The maintenance code entered in the third position will indicate the lowest maintenance level authorized to remove, replace, and use the support item. The maintenance code entered in the third position will indicate one of the following levels of maintenance:

<i>Code</i>	<i>Application Explanation</i>
O-Support item is removed, replaced, used at the organizational level.	
F-Support item is removed, replaced, used at the direct support level.	

(b) The maintenance code entered in the fourth position indicates whether the item is to be repaired and identifies the lowest maintenance level with the capability to perform complete repair (i.e., all authorized maintenance functions). This position will contain one of the following maintenance codes:

<i>Code</i>	<i>Application/Explanation</i>
F-The lowest maintenance level capable of complete repair of the support item is the direct support level.	
Z-Nonrepairable. No repair is authorized.	

(3) *Recoverability code.* Recoverability codes are assigned to support items to indicate the disposition action on unserviceable items. The recoverability code is entered in the fifth position of the Uniform SMR Code format as follows:

<i>Recoverability code</i>	<i>Definition</i>
D-Repairable item. When beyond lower level repair capability, return to depot. Condemnation and disposal not authorized below depot level.	
Z-Nonrepairable item. When unserviceable, condemn and dispose. at the level indicated in position 3.	

c. National Stock Number. Indicates the National stock number assigned to the item and will be used for requisitioning purposes.

d. Part Number. Indicates the primary number used by the manufacturer (individual, company, firm,

corporation, or Government activity), which controls the design and characteristics of the item by means of its engineering drawings, specifications, standards, and inspection requirements to identify an item or range of items.

NOTE

When a stock-numbered item is requisitioned, the repair part received may have a different part number than the part being replaced.

e. Federal Supply Code for Manufacturer (FSCM). The FSCM is a 5-digit numeric code listed in SB 708-42 which is used to identify the manufacturer, distributor, or Government agency, etc.

f. Description. Indicates the Federal item name and, if required, a minimum description to identify the item.

g. Unit of Measure (U/M). Indicates the standard of the basic quantity of the listed item as used in performing the actual maintenance function. This measure is expressed by a two-character alphabetical abbreviation (e.g., ea., in., pr., etc.). When the unit of measure differs from the unit of issue, the lowest unit of issue that will satisfy the required units of measure will be requisitioned.

h. Quantity Incorporated in Unit. Indicates the quantity of the item used in the breakout shown on the illustration figure, which is prepared for a functional group, subfunctional group, or an assembly. A "V" appearing in this column in lieu of a quantity indicates that no specific quantity is applicable (e.g., shims, spacers, etc.).

4. Special Information

a. The following publication pertains to the RT-718/FRC-93 and its components:

TM 11-5820-554-12, Operator's and organizational maintenance manual for Radio Set AN/FRC-93 (NSN 5820-00-082-4276).

b. National stock numbers (NSN's) that are missing from P source-coded items have been applied for and will be added to this TM by future change/revision when they are entered in the Army Master Data File (AMDF). Until the NSN's are established and published, submit exception requisitions to: Commander, US Army Electronics Command, ATTN: DRSEL-MM, Fort Monmouth, NJ 07703 for the part required to support your equipment.

5. How to Locate Repair Parts

a. When National stock number or part number is unknown:

(1) *First.* Using the table of contents, determine the subgroup within which the repair part belongs. This is necessary since illustrations are prepared for subgroups and listings are divided into the same groups.

(2) *Second.* Find the illustration covering the subgroup to which the repair part belongs.

(3) *Third.* Identify the repair part on the illustration and note the illustration figure and item number of the repair part.

(4) *Fourth.* Using the Repair Parts Listing, find the figure and item number noted on the illustration.

b. When National stock number or part number is known:

(1) *First.* Using the Index of National Stock Numbers and Part Numbers, find the pertinent National stock number or part number. This index is in ascending NSN sequence, followed by a list of part numbers in ascending alphanumeric sequence, cross-referenced to the illustration figure number and item number.

(2) *Second.* After finding the figure and item number, locate the figure and item number in the repair parts list.

6. Abbreviations

(Not applicable)

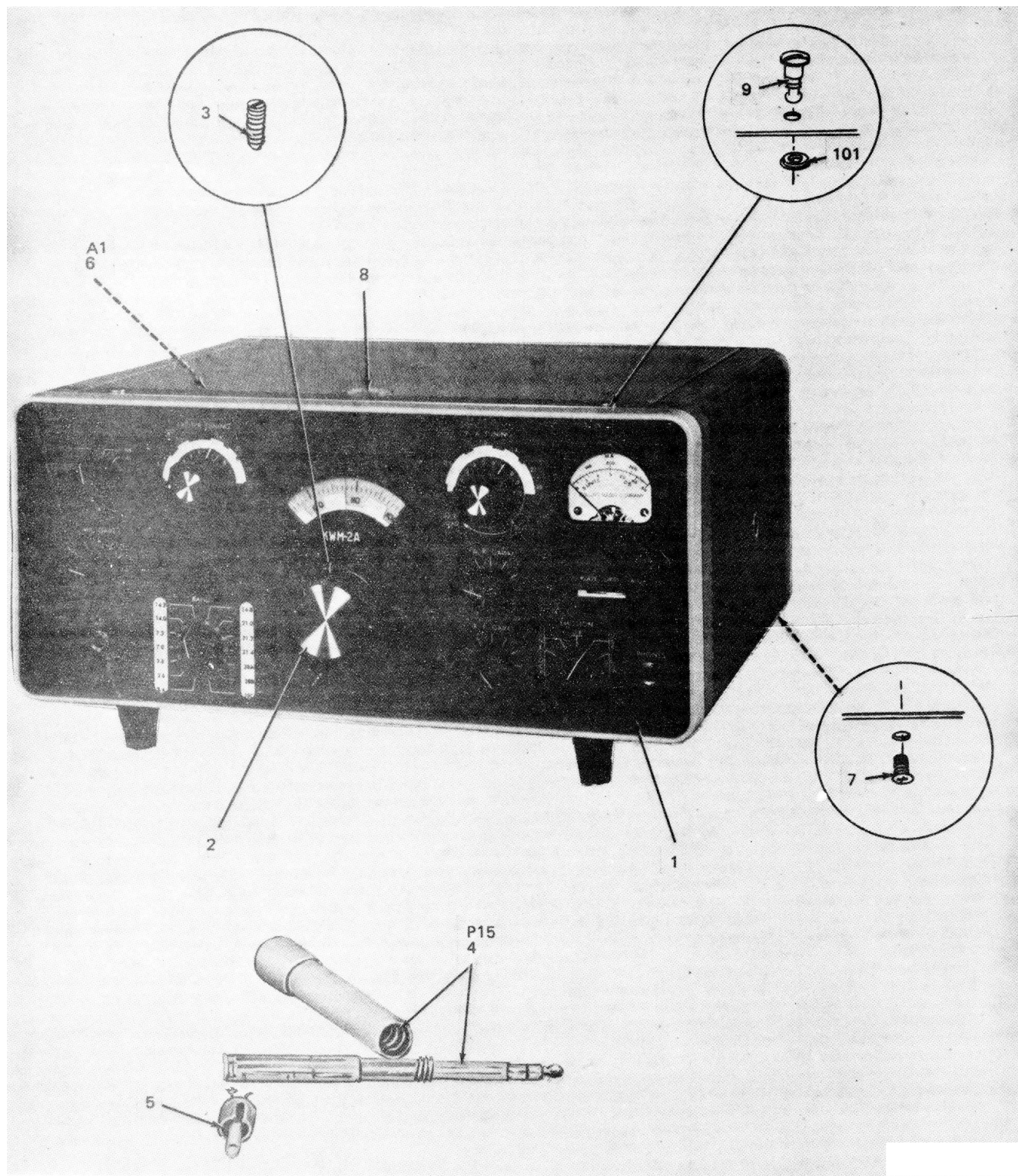

ELIPW001

Figure 1. Receiver-Transmitter, Radio RT-718/FRC-93.

SECTION II. REPAIR PARTS LIST

(1) ILLUSTRATION		(2)	(3)	(4)	(5)	(6)	(7)	(8)
(A) FIG NO.	(B) ITEM NO.	SMR CODE	NATIONAL STOCK NUMBER	PART NUMBER	FSCM	DESCRIPTION USABLE ON CODE	UNIT OF MEAS	QTY INCL IN UNIT
						GROUP: 00 RECEIVER-TRANSMITTER, RADIO RT- 718/FRC-93		
1	1	PAFFD	5820-00-082-4080	RT718FRC93	80058	RECEIVER TRANSMITTER, RADIO	EA	1
1	2	PAOZZ	5355-00-906-1161	553-5787-003	13499	KNOB	EA	1
1	3	XDFZZ	5305-00-827-3953	335-0041-000	08664	SETSCREW, SPLINED, OVAL POINT	EA	2
1	4	PAFZZ	5935-00-192-4753	PJ068	81349	PLUG, TELEPHONE	EA	1
1	5	PAFZZ	5935-00-856-4005	3501MC	82389	PLUG, TIP	EA	2
						GROUP: 01 CABINET. RECEIVER		
1	6	XAFZZ	5975-00-901-4348	544-9745-005	13499	CABINET, RECEIVER	EA	1
1	7	XDFZZ	5305-00-245-4735	P342-0168-000	77250	SCREW, MACHINE	EA	2
1	8	PAFZZ	5325-00-017-6972	628-0774-001	13499	GROMMET, COVER	EA	1
1	9	PAFZZ	5325-00-281-5088	82-11-180-16	94222	STUD, TURNLOCK FASTENER	EA	2
1	10	PAFZZ	5325-00-920-0887	82-31-293-15	75618	EYELET, TURNLOCK FASTENER	EA	2

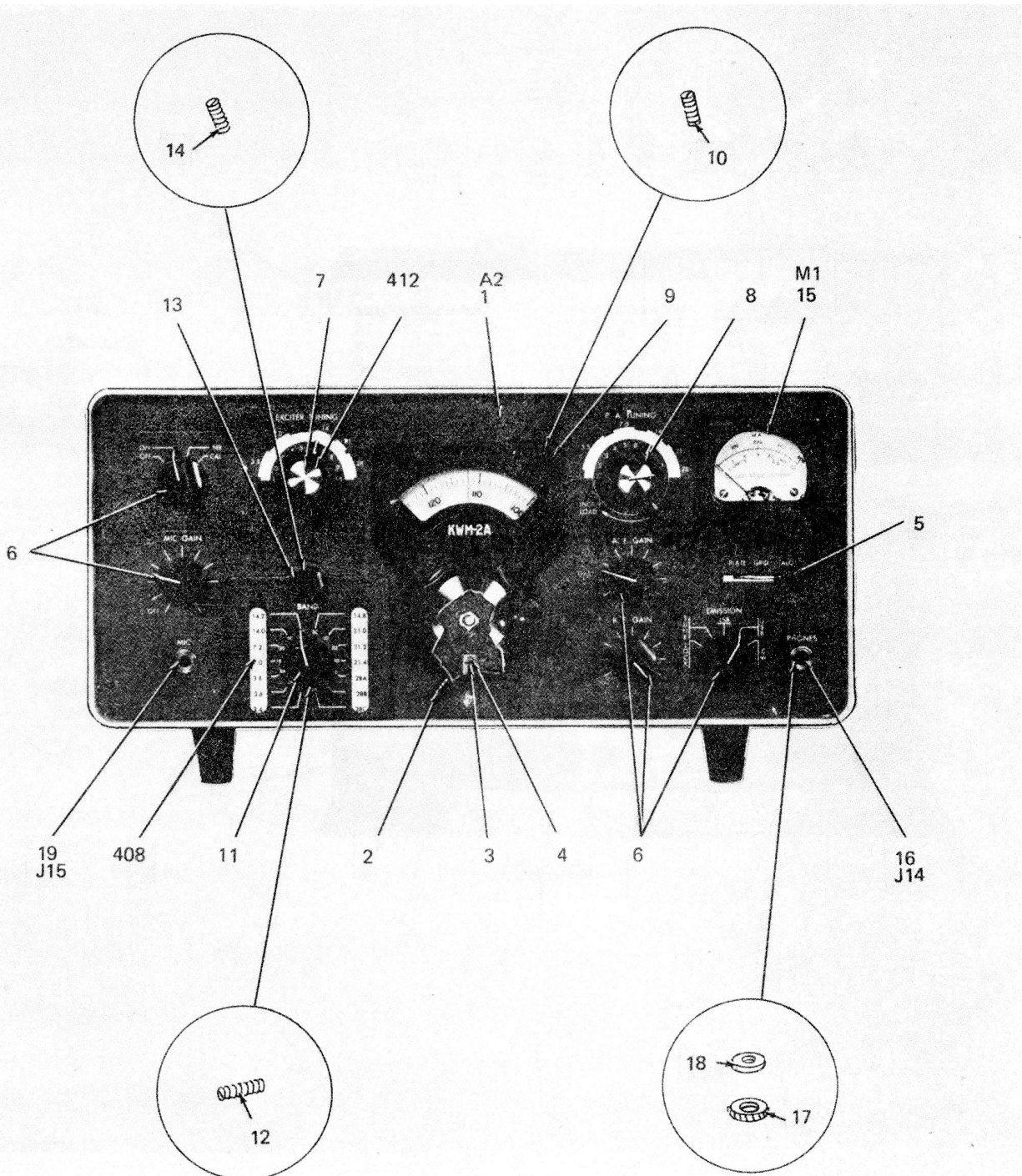

PREFIX ALL REFERENCE DESIGNATIONS WITH A2

Figure 2. ① Chassis subassembly (Sheet 1 of 20).

ELIPW002

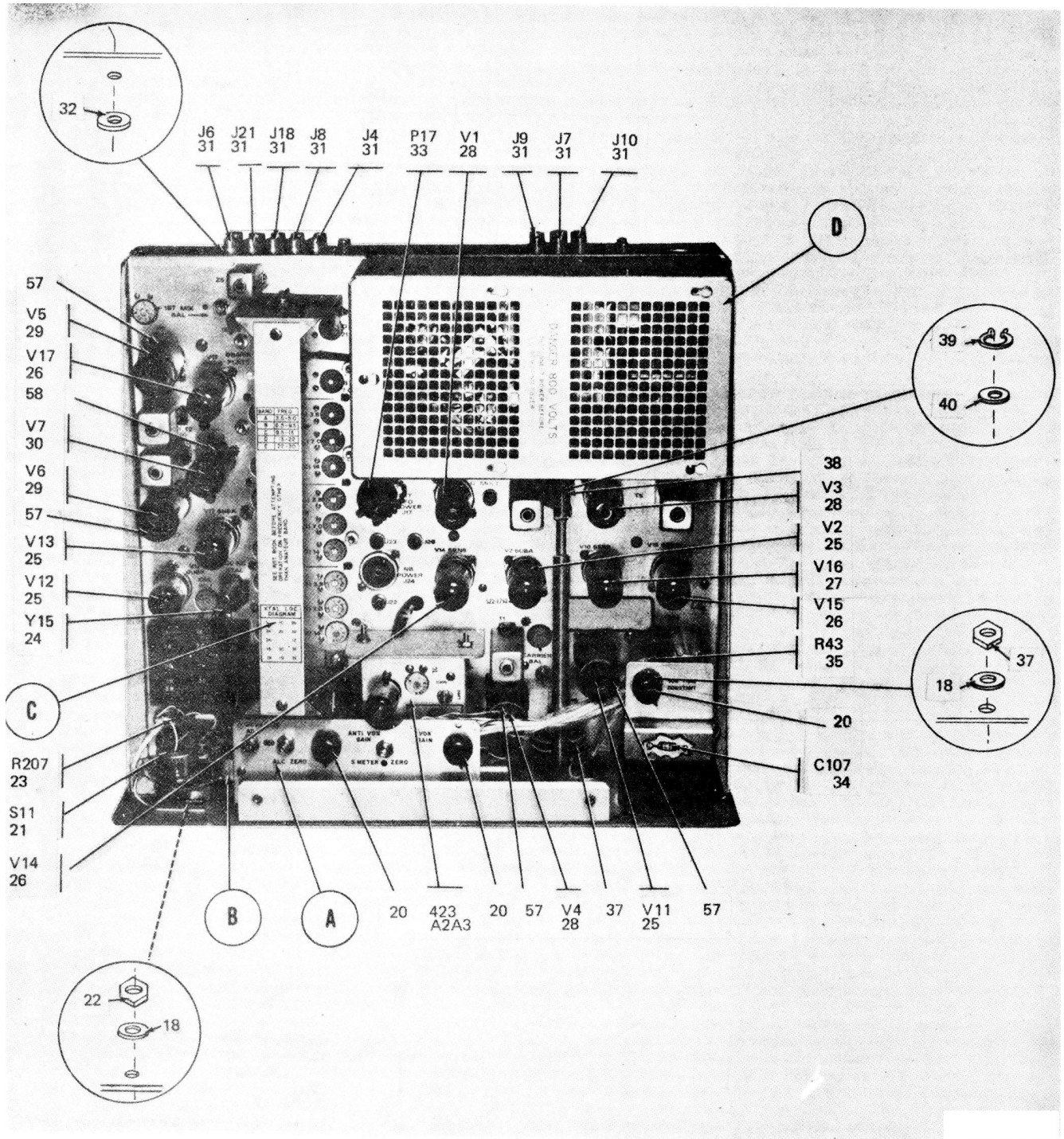

ELIPW003

Figure 2. ② Chassis subassembly (Sheet 2 of 20).

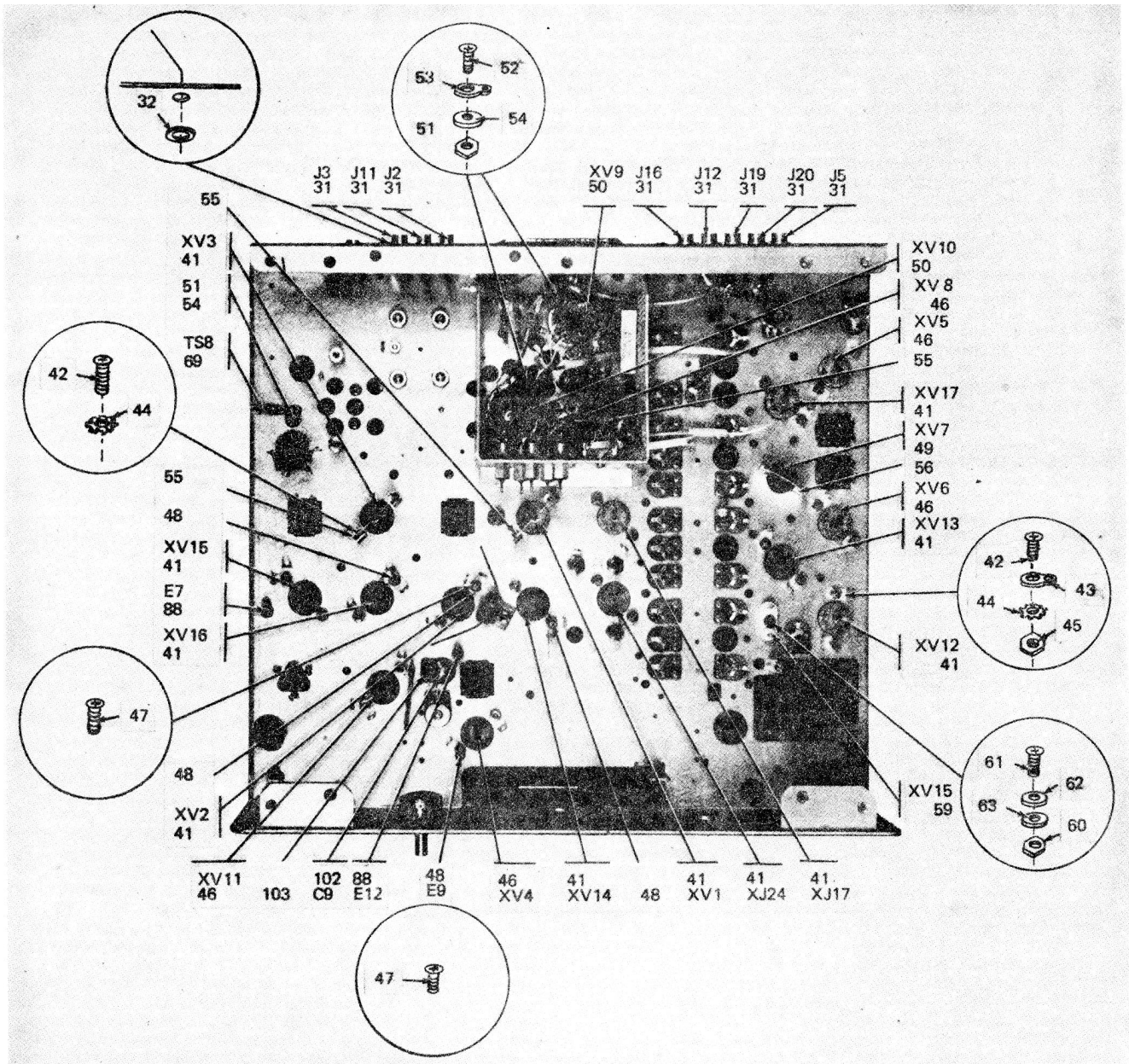

ELIPW004

Figure 2. ③ Chassis subassembly (Sheet 3 of 20)

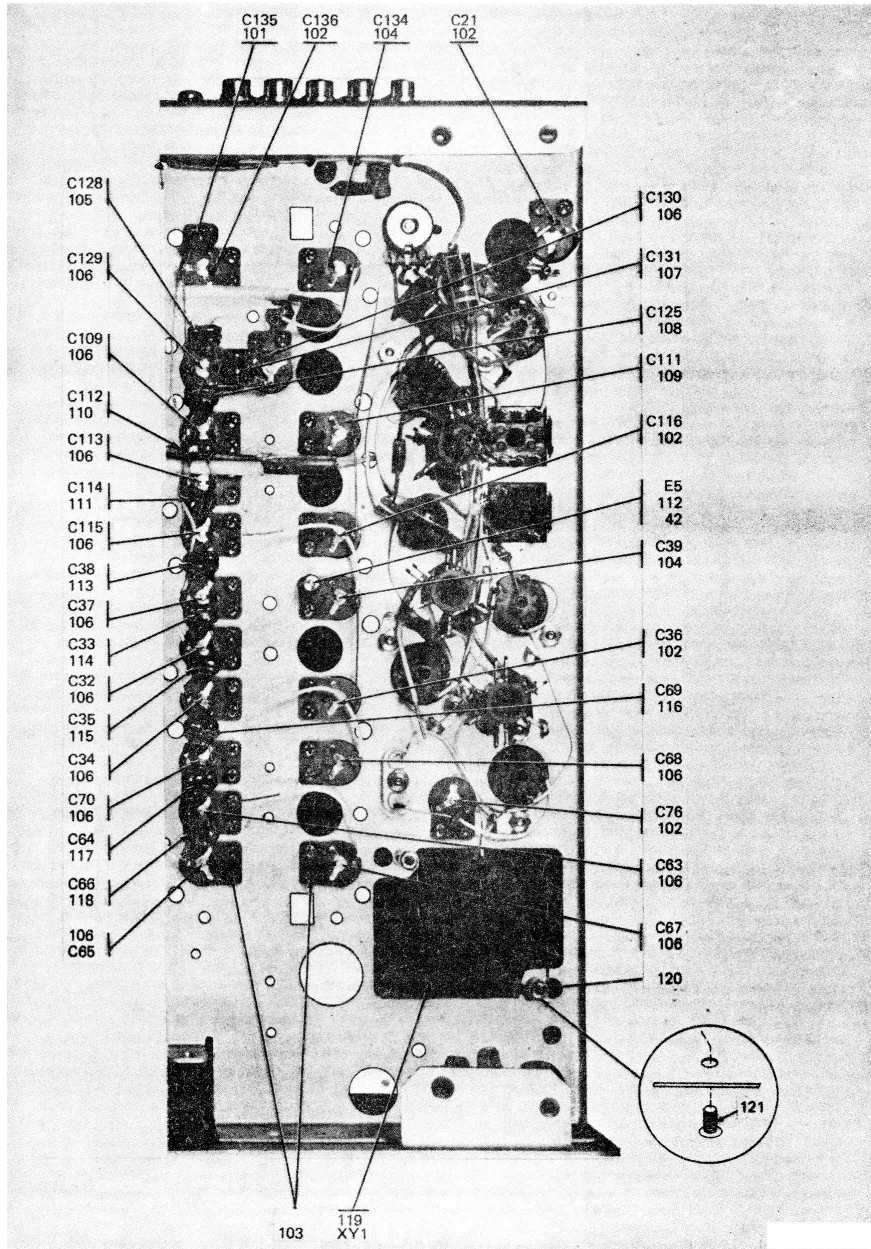

ELIPW005

Figure 2 ⑤ Chassis subassembly (Sheet 5 of 20)

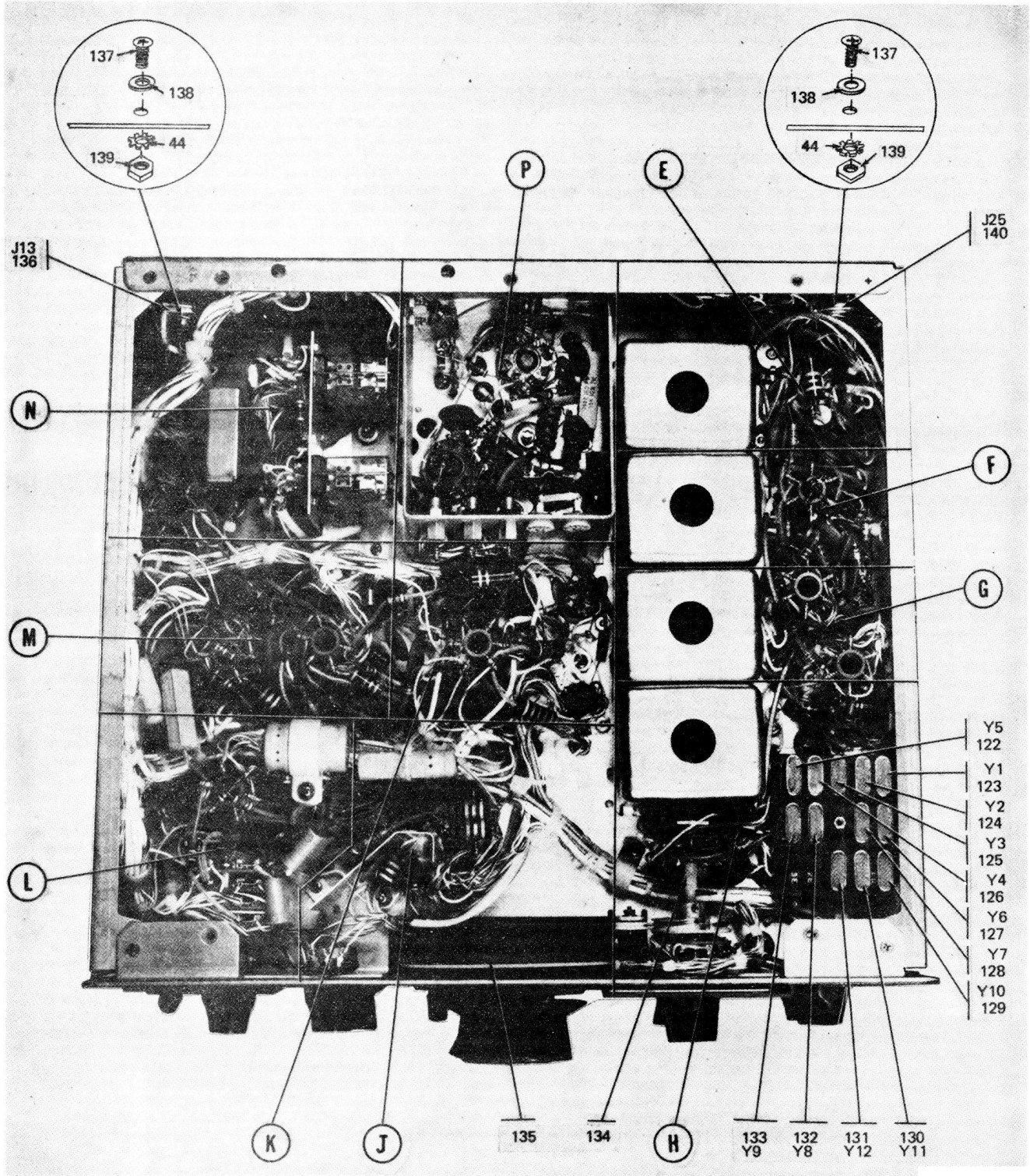

ELIPW007

Figure 2 © Chassis subassembly (Sheet 6 of 20)

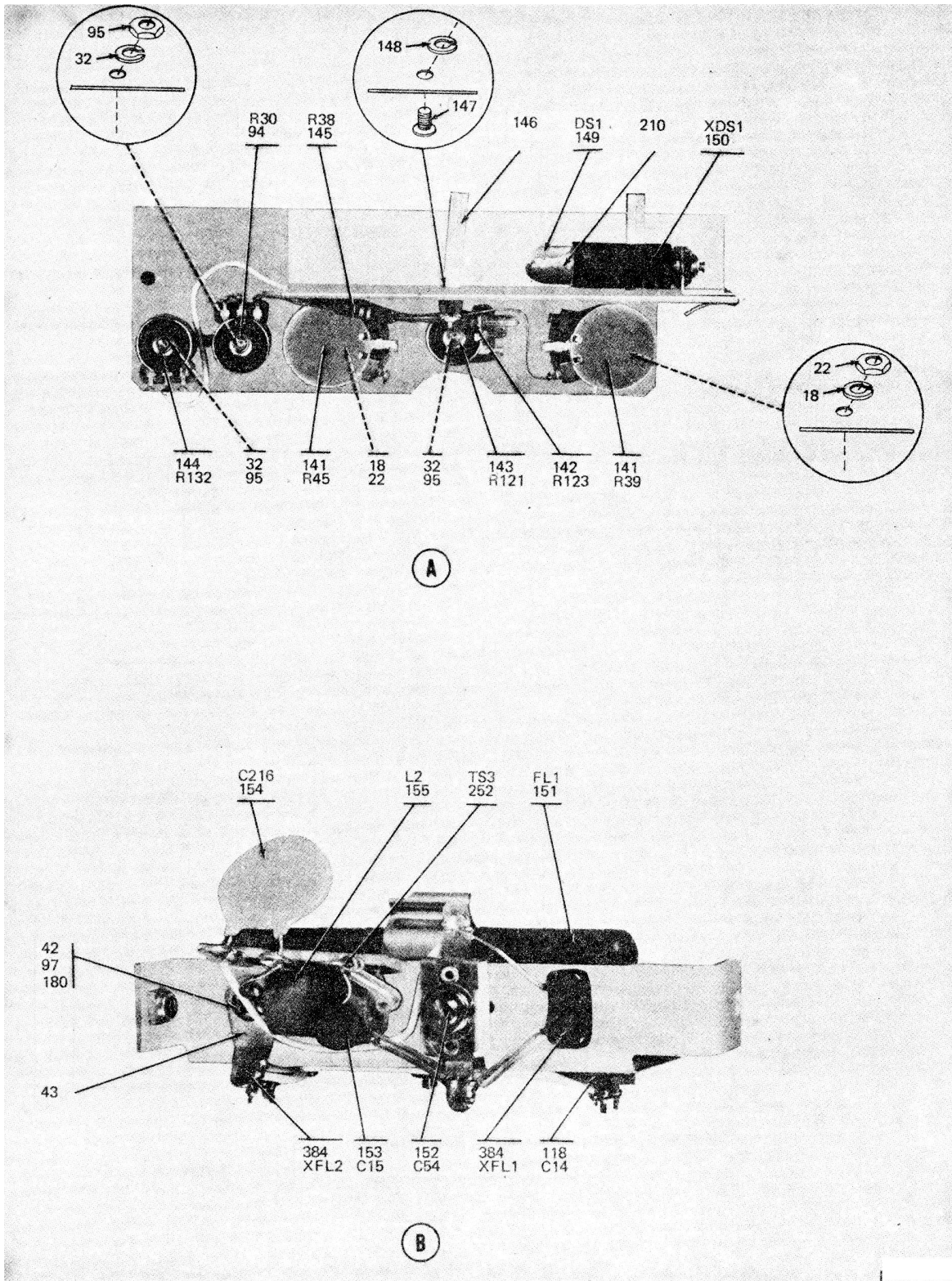

ELIPW008

Figure 2 Chassis Subassembly (Sheet 7 of 20)

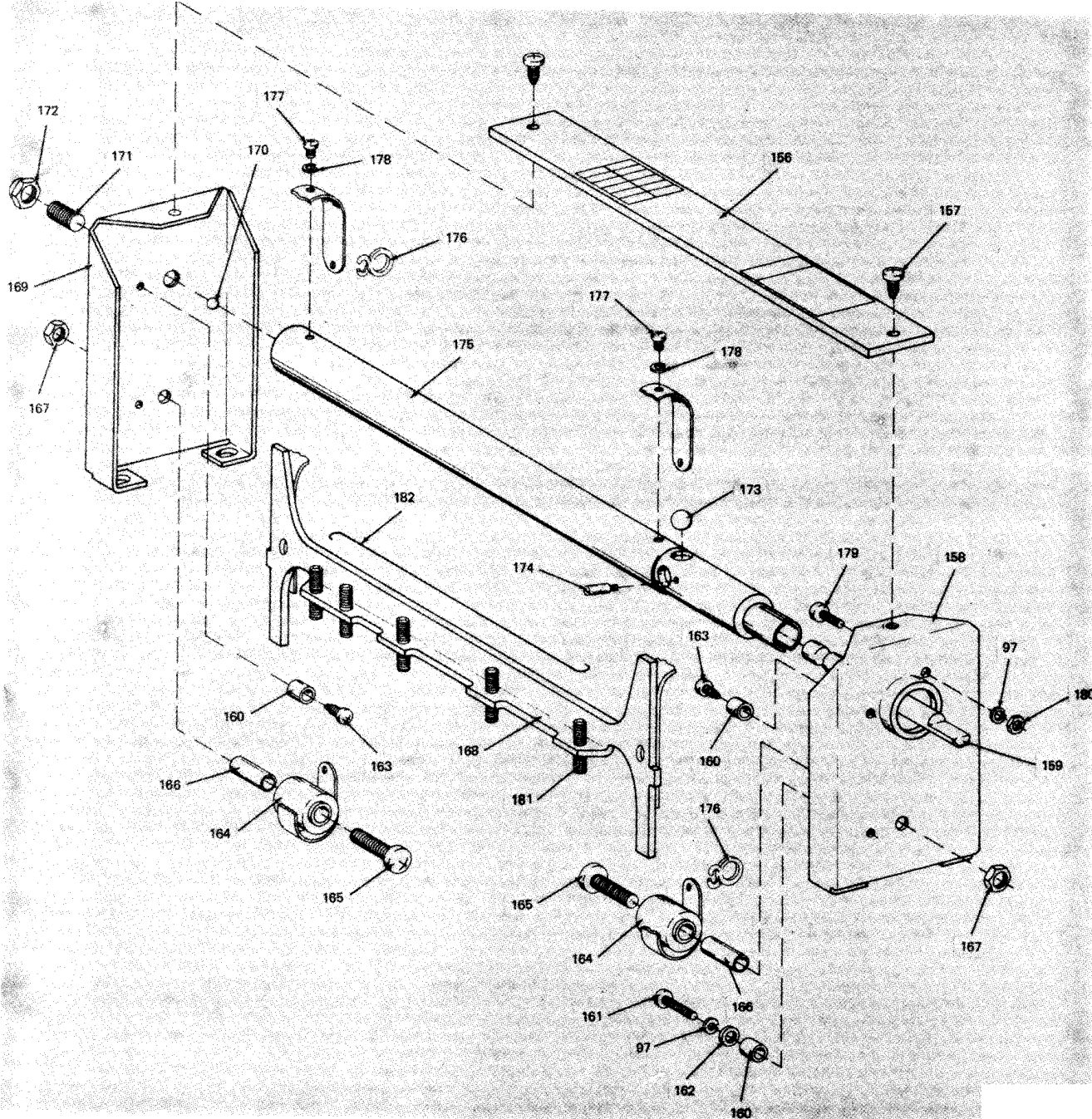
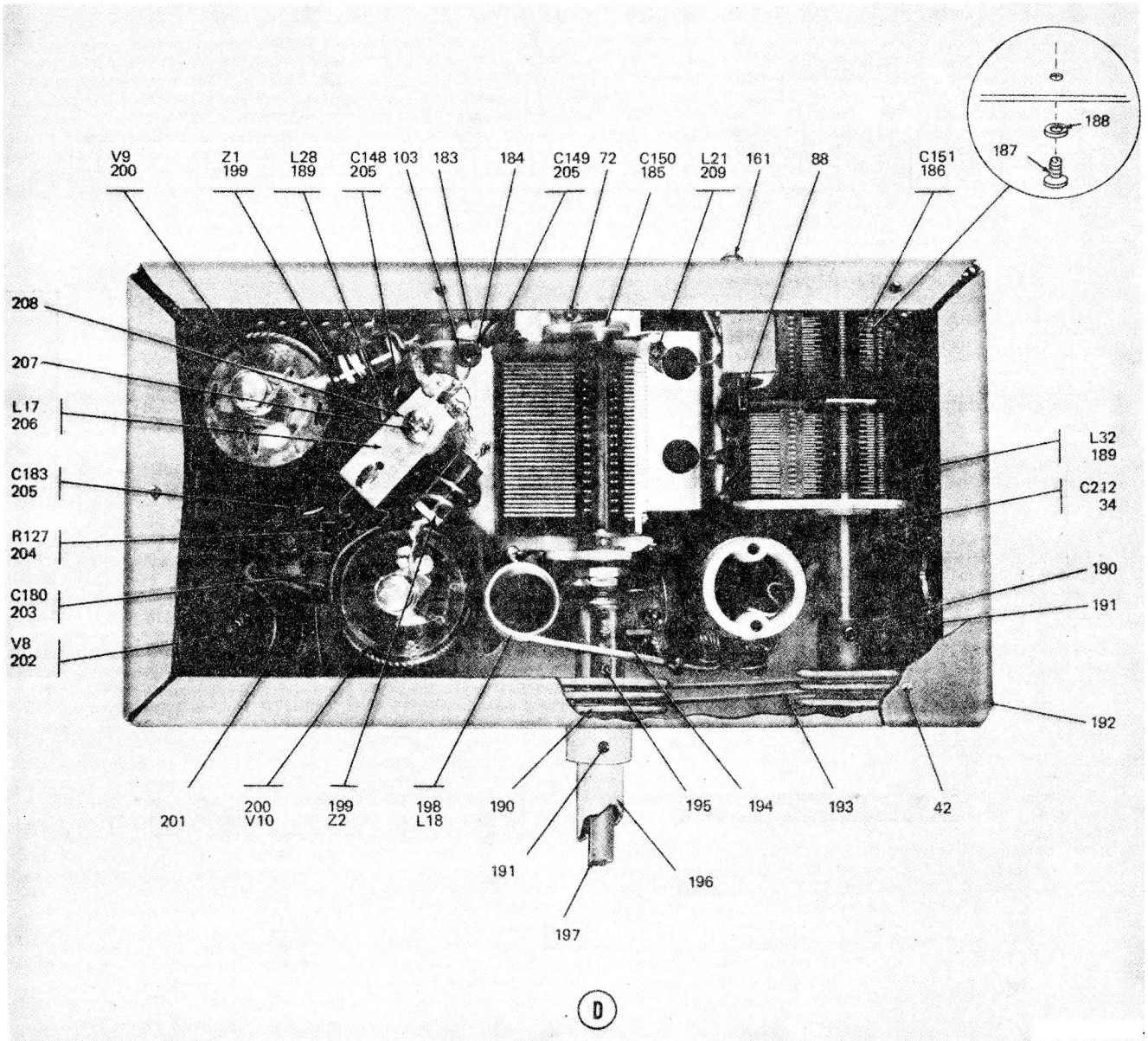

Figure 2 @ Chassis subassembly (Sheet 8 of 20).

ELIPW009



ELIPW010

Figure 2Ⓣ Chassis subassembly (Sheet 9 of 20).

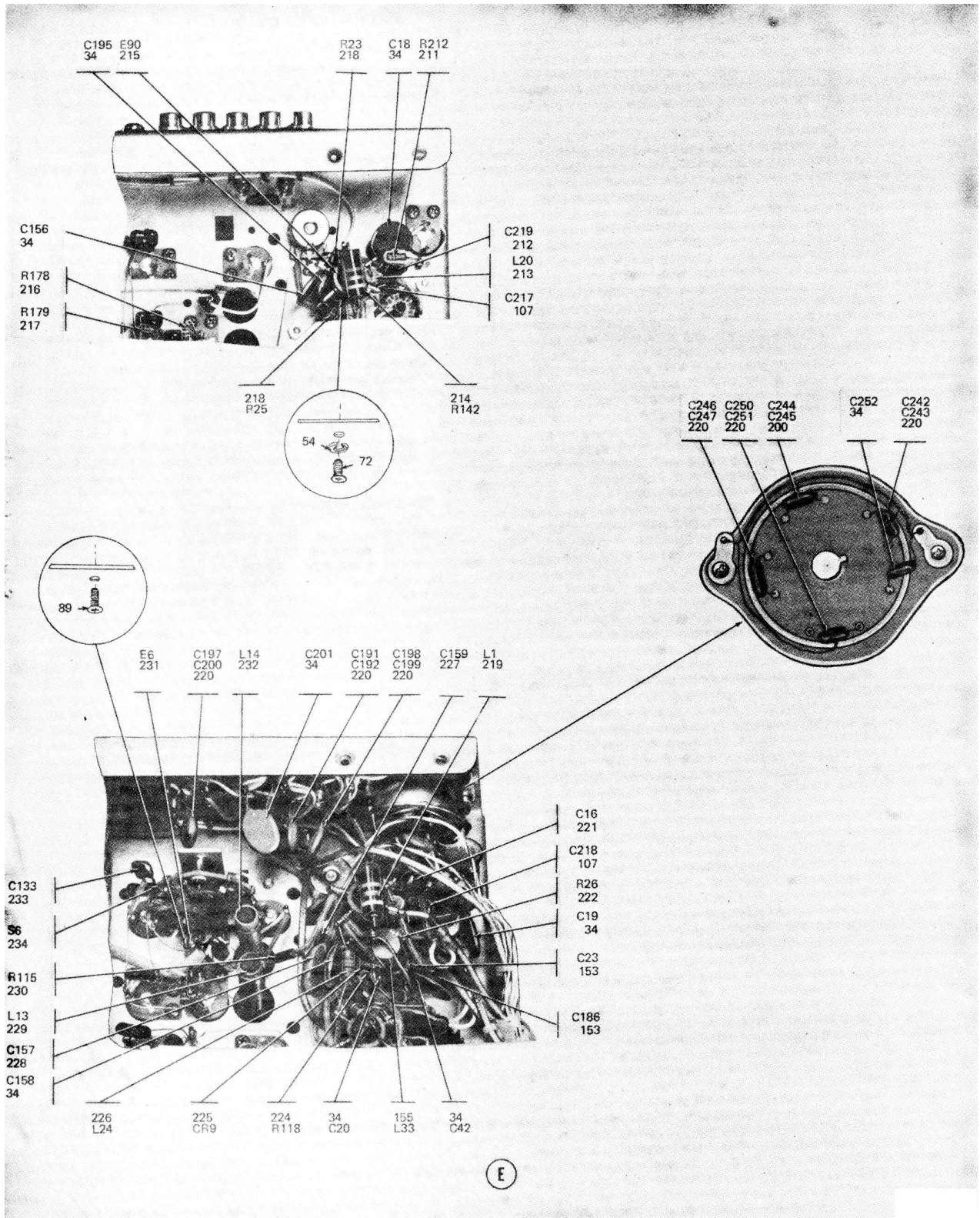

ELIPW011

Figure 2. ⑩ Chassis subassembly (Sheet 10 of 20)

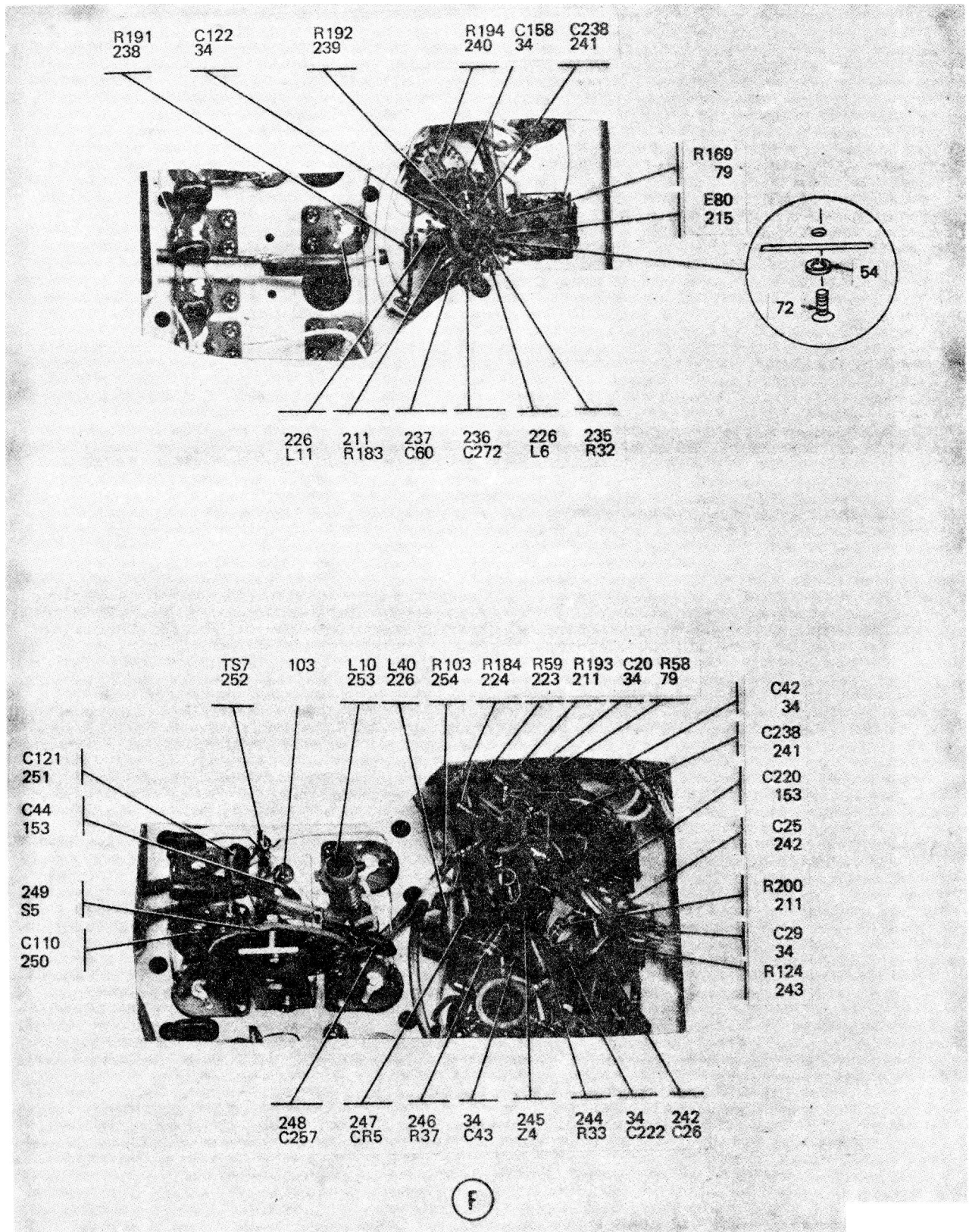

ELIPW012

Figure 2. (1) Chassis subassembly (sheet 11 Of 20)

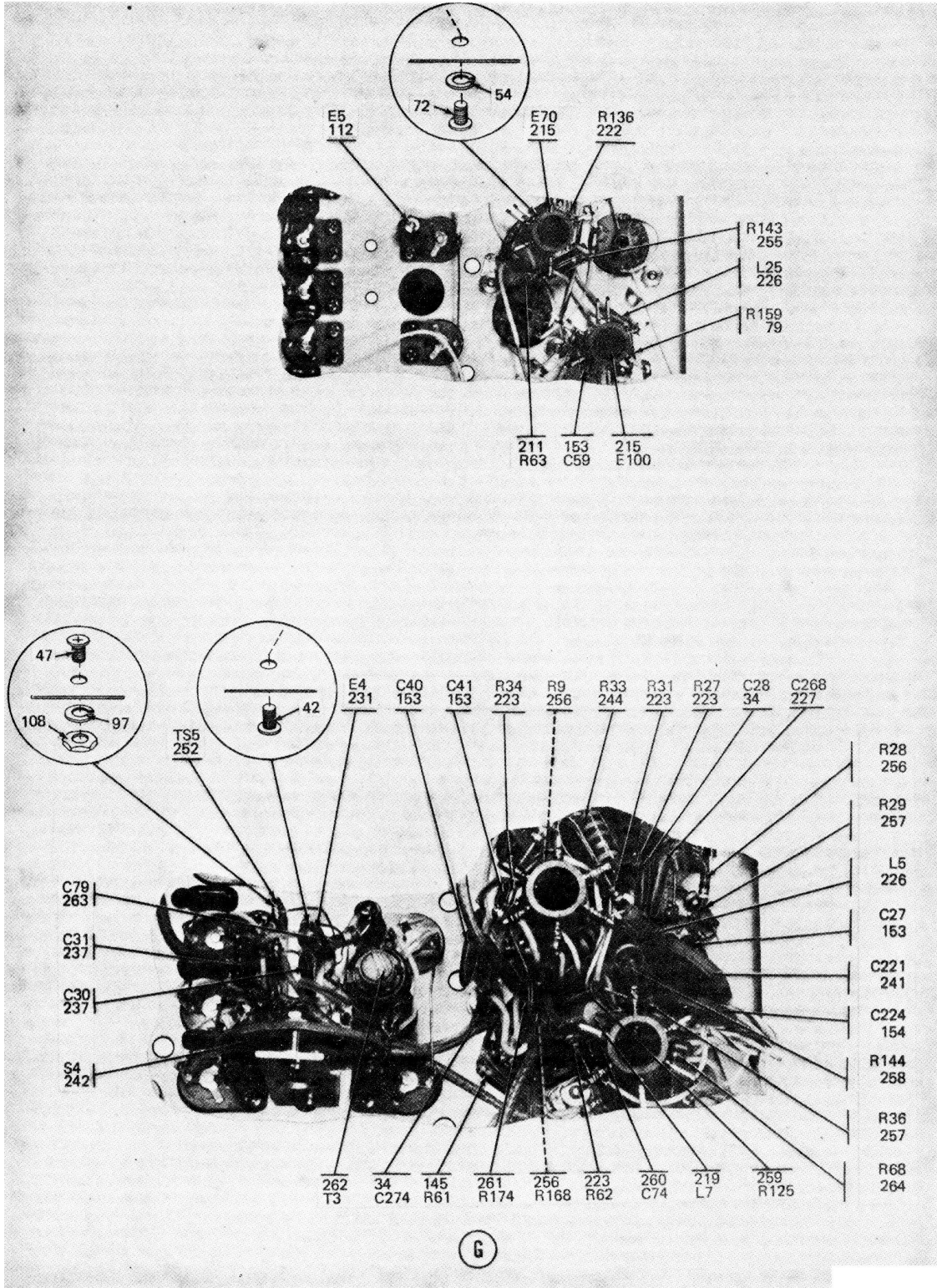

ELIPW013

Figure 2. (12) Chassis subassembly (Sheet 12 of 20)

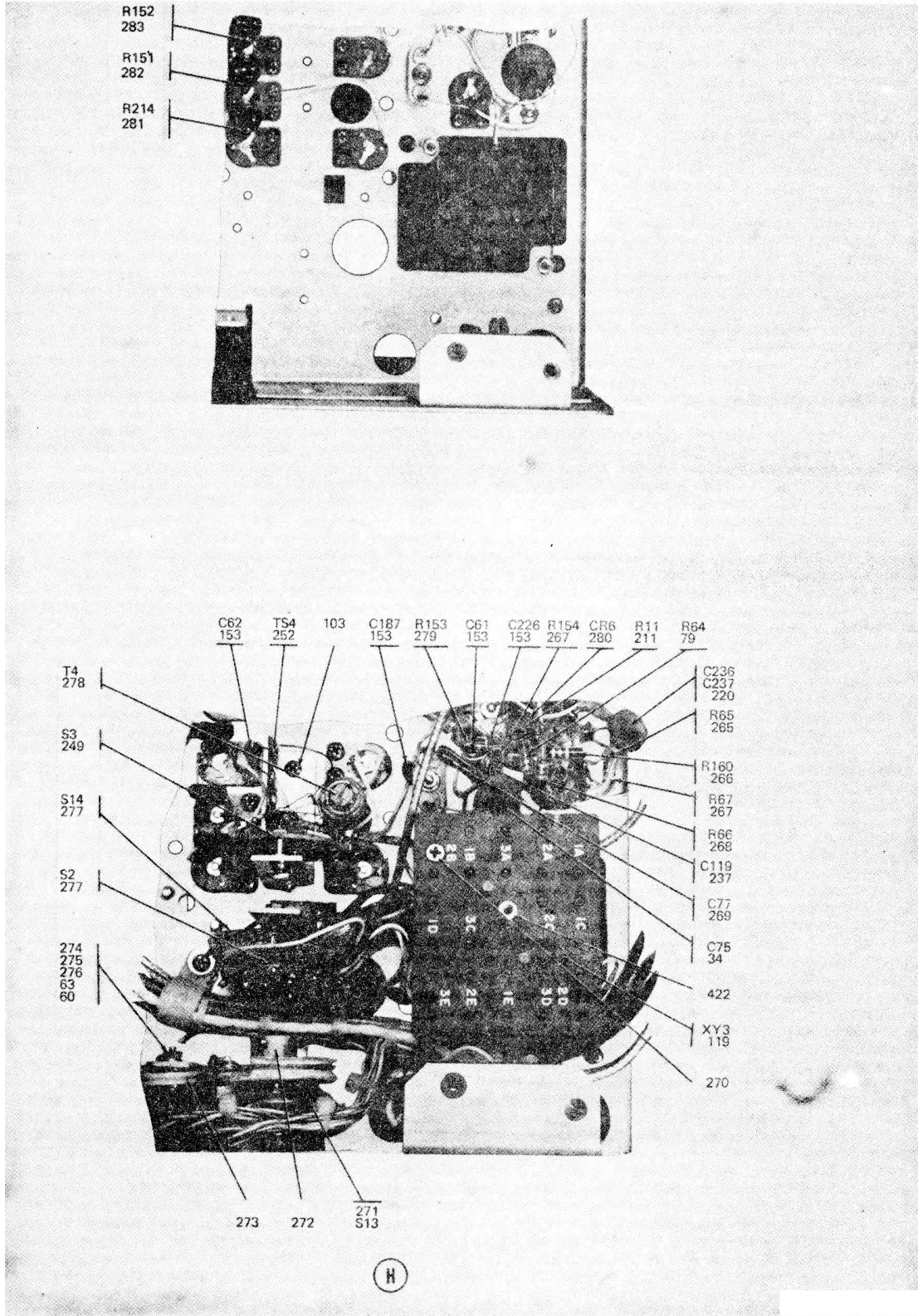

ELIPW014

Figure 2. (13) Chassis subassembly (Sheet 13 of 20).

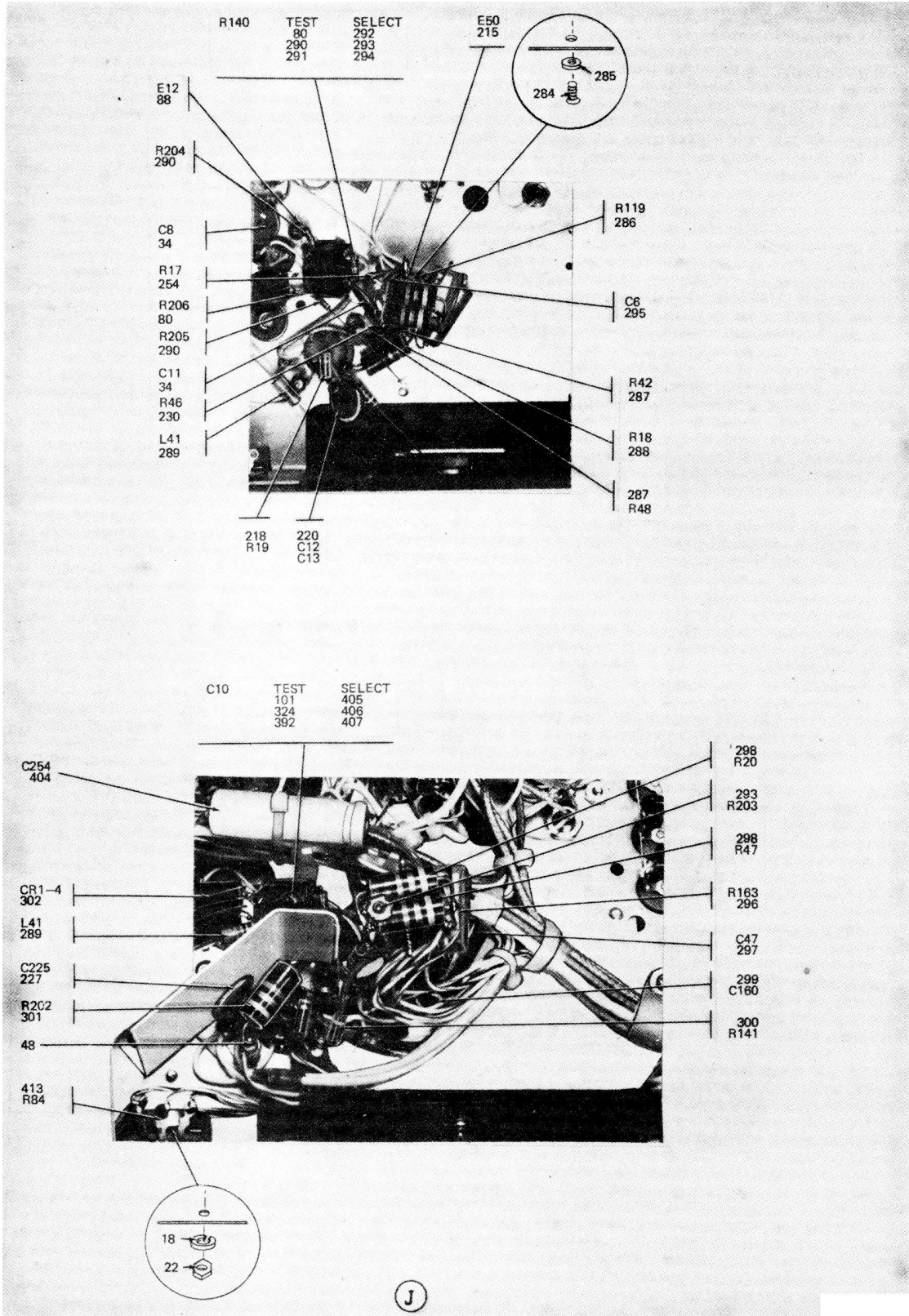

ELIPW015

Figure 2. (14) Chassis subassembly (Sheet 14 of 20).

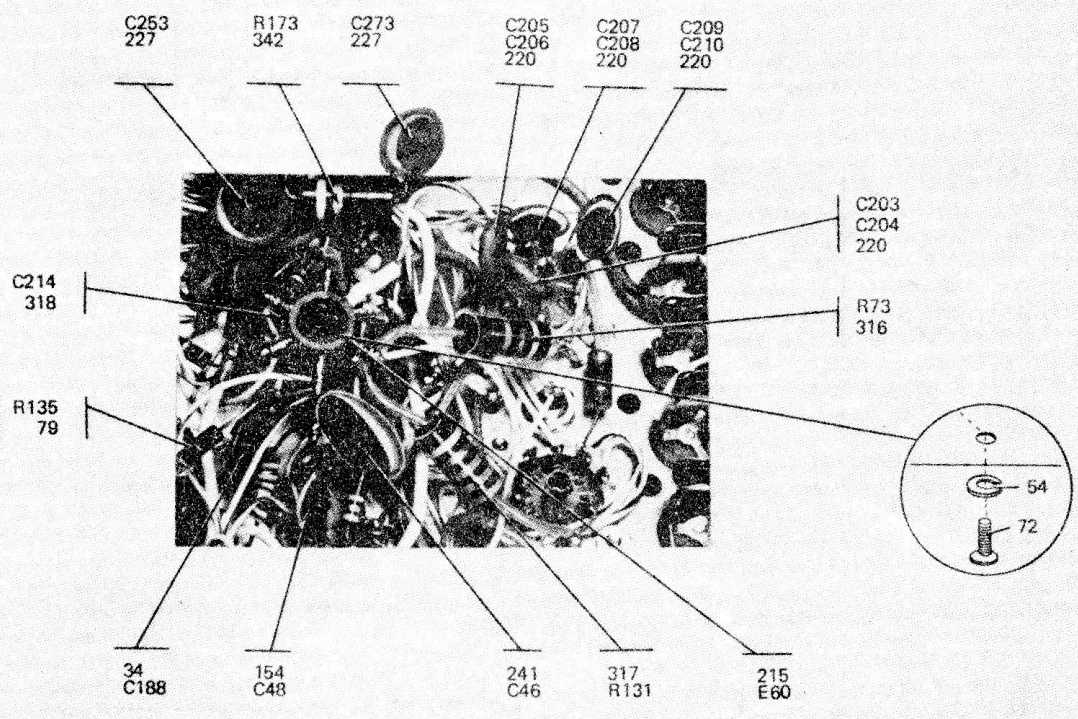
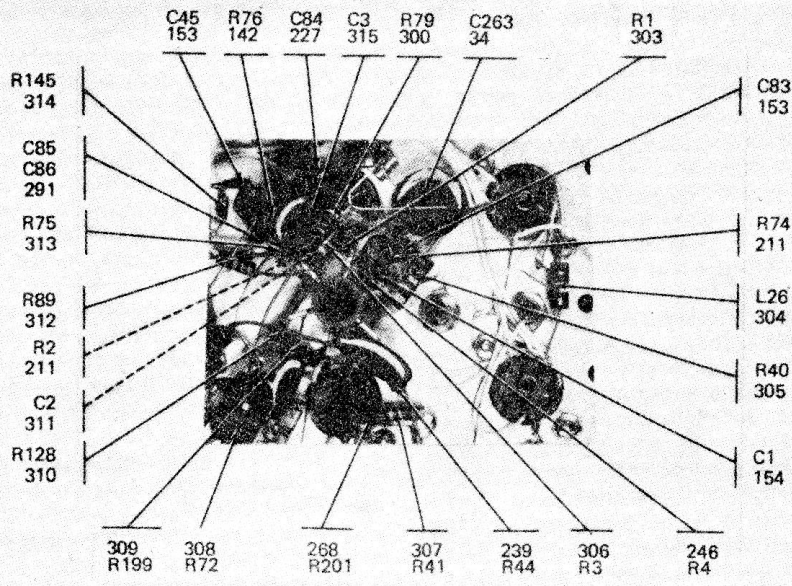

ELIPW016

Figure 2. (15) Chassis subassembly (Sheet 15 of 20).

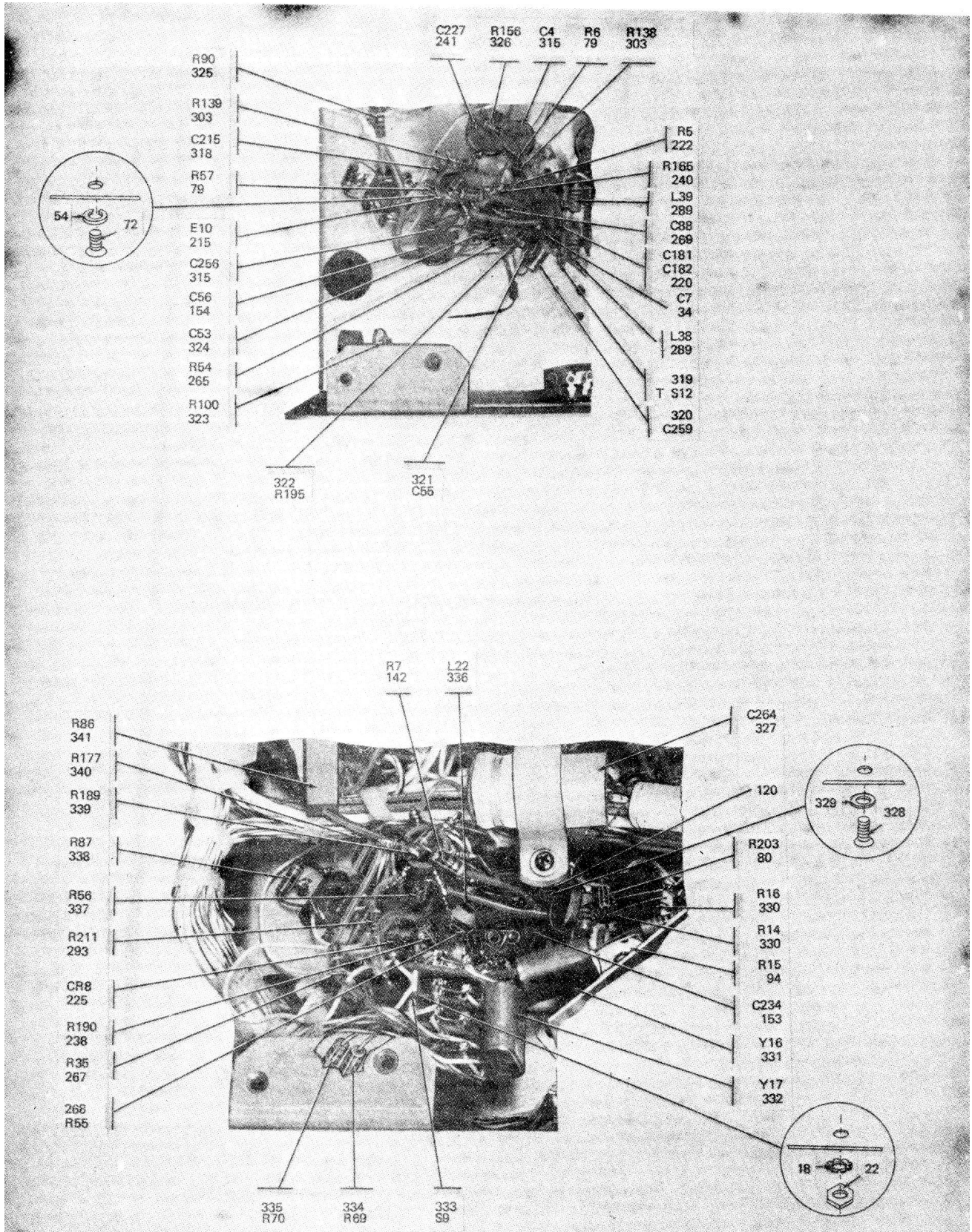

ELIPW017

Figure 2. (16) Chassis subassembly (Sheet 16 of 20).

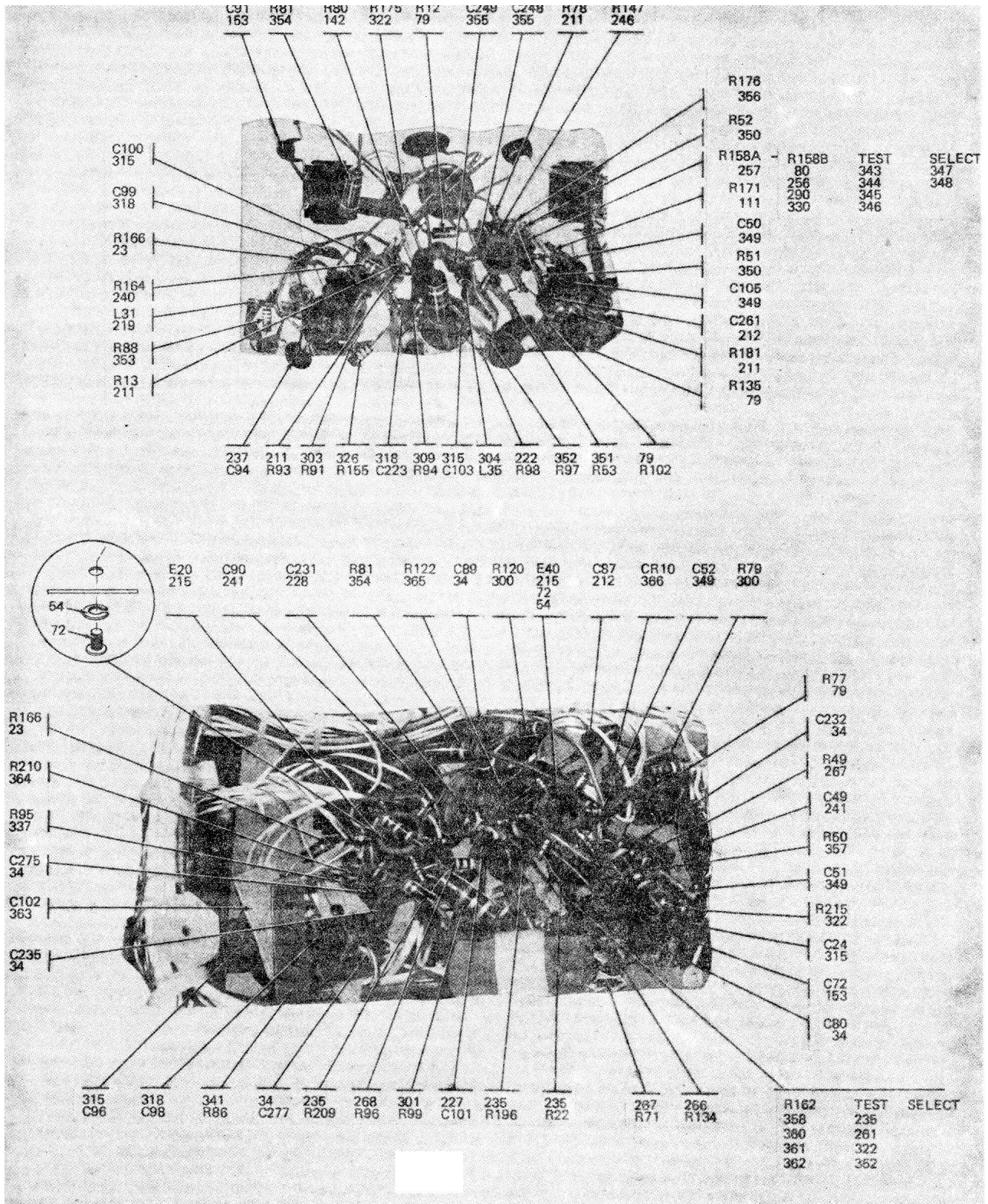

ELIPW018

Figure 2. (17) Chassis subassembly (Sheet 17 of 20).

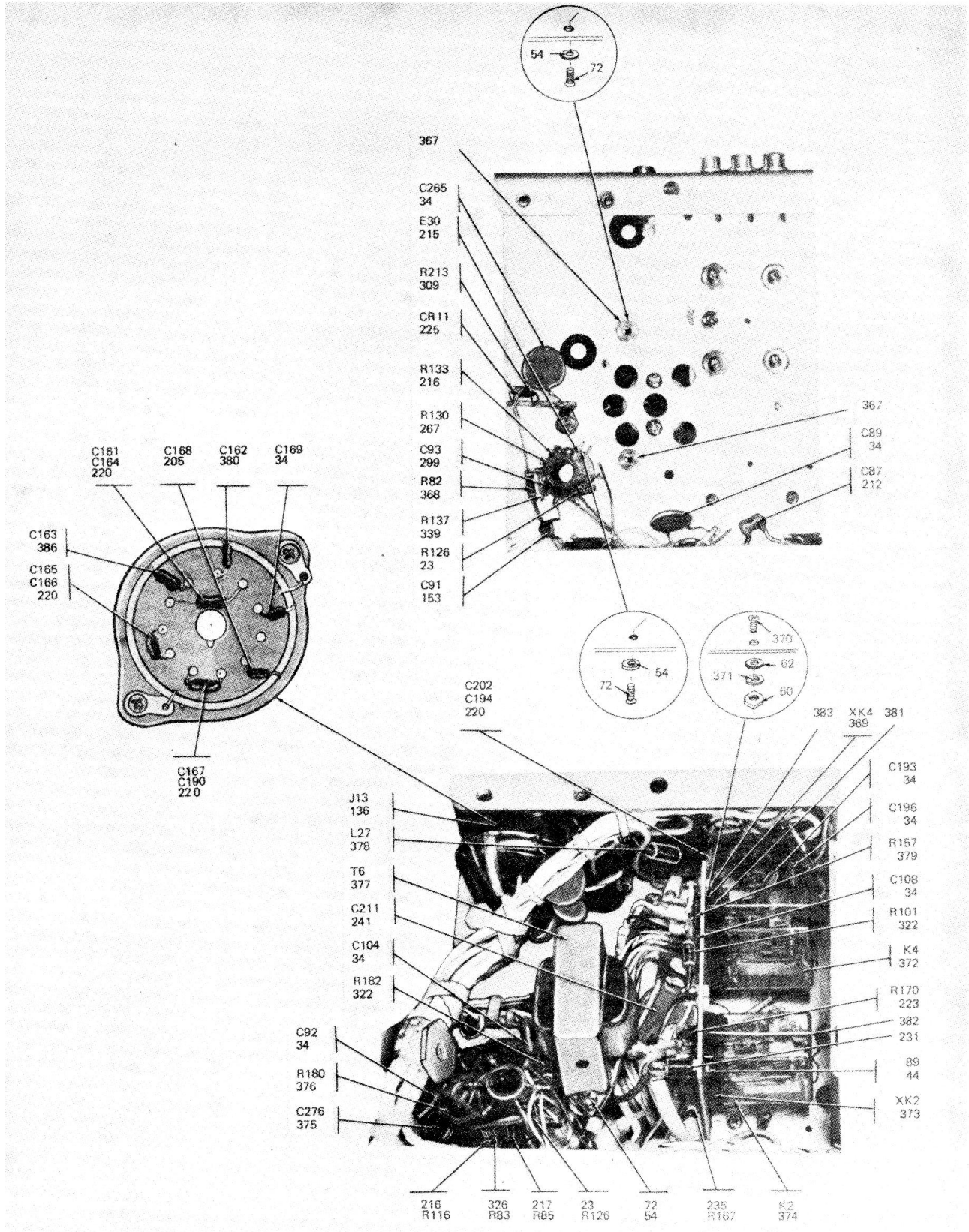

ELIPW019

Figure 2. (18) Chassis subassembly (Sheet 18 of 20).

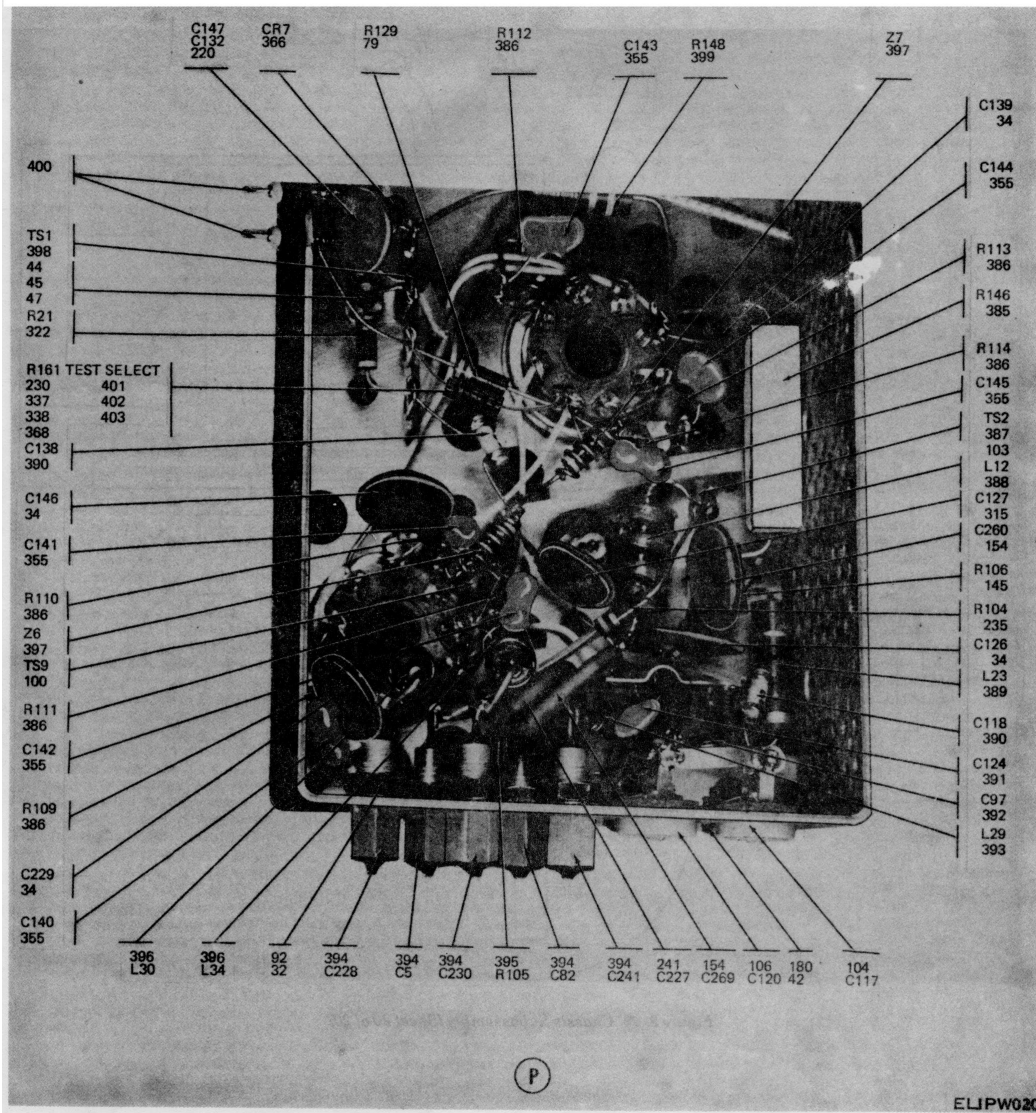

Figure 2. 19 Chassis subassembly (Sheet 19 of 20).

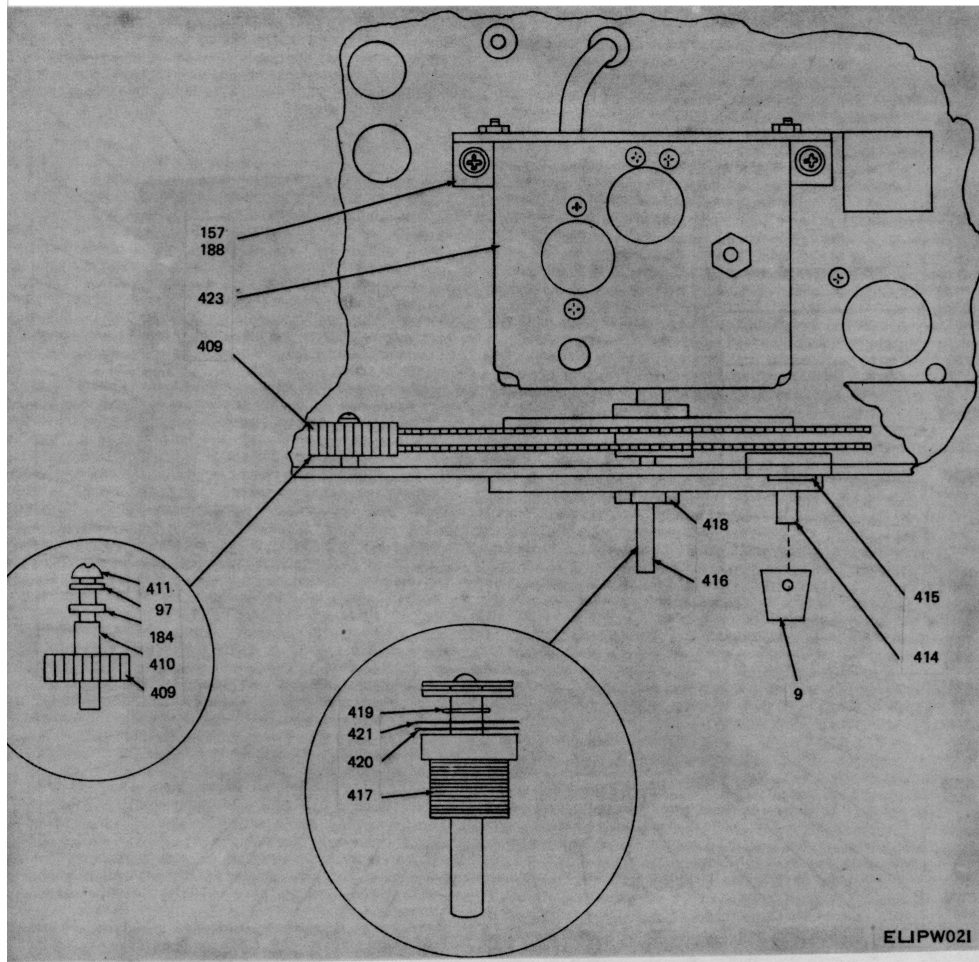

Figure 2. 20 Chassis Subassembly (Sheet 20 of 20).

SECTION II. REPAIR PARTS LIST (CONTINUED)

(1) ILLUSTRATION		(2)	(3)	(4)	(5)	(6)	(7)	(8)
(A) FIG NO.	(B) ITEM NO.	SMR CODE	NATIONAL STOCK NUMBER	PART NUMBER	FSCM	DESCRIPTION <i>USABLE ON CODE</i>	UNIT OF MEAS	QTY INCL IN UNIT
						GROUP: 02 CHASSIS, SUBASSEMBLY		
2	1	XAFZZ		545-9114-000	13499	CHASSIS SUBASSEMBLY	EA	1
2	2	PAFZZ	5820-00-930-8487	757-8614-001	13499	ARM, LOCK	EA	1
2	3	PAFZZ	5820-00-936-0683	757-8613-001	13499	BUSHING	EA	1
2	4	XDFZZ	5325-00-770-2580	MS51959-16	96906	SCREW, MACHINE	EA	1
2	5	PA0ZZ	5355-00-051-6855	281-0330-000	18986	KNOB	EA	1
2	6	PA0ZZ	5355-00-971-0588	543-8039-000	13499	KNOB	EA	5
2	7	PA0ZZ	5355-00-971-0589	543-8043-000	13499	KNOB	EA	1
2	8	PA0ZZ	5355-00-972-0590	543-8044-000	13499	KNOB	EA	1
2	9	PA0ZZ	5355-00-063-3060	543-8078-002	13499	KNOB	EA	1
2	10	XDFZZ	5305-00-685-7329	328-0005-000	08664	SETSCREW	EA	1
2	11	PA0ZZ	5355-00-778-4967	544-0779-004	13499	KNOB	EA	1
2	12	XDFZZ		328-0473-000	08664	SETSCREW	EA	1
2	13	PA0ZZ	5355-00-063-3061	544-7268-002	13499	KNOB	EA	1
2	14	XDFZZ		328-0506-020	08664	SETSCREW	EA	1
2	15	PAFZZ		458-0491-000	13499	METER, AUDIO LEVEL	EA	1
2	16	PAFZZ	5935-00-819-5758	13A	82389	JACK, TELEPHONE	EA	1
2	17	XDFZZ		N020BRASS	08591	NUT, PLAIN, KNURLED	EA	2
2	18	XDFZZ	5310-00-883-5931	1720-02	78189	WASHER, LOCK	EA	11
2	19	PAFZZ	5935-00-192-4729	M641-5-1	81349	JACK, TELEPHONE	EA	1
2	20	PA0ZZ	5355-00-878-9454	1400W	72512	KNOB	EA	3
2	21	PAFZZ	5930-00-856-6278	196302F1AC	76854	SWITCH SECTION	EA	1
2	22	XDFZZ	5310-00-282-4653	P334-4060-000	77250	NUT, PLAIN HEXAGON	EA	8
2	23	PAFZZ	5905-00-111-8357	RCR20G681KS	81349	RESISTOR, FIXED, COMPOSITION	EA	3
2	24	PA0ZZ	5955-00-860-1245	BL289-1424-000	71034	CRYSTAL UNIT, QUART Z	EA	1
2	25	PA0ZZ		6U8A	81349	ELECTRON TUBE	EA	4
2	26	PA0ZZ	5960-00-854-8467	6BN8	82219	ELECTRON TUBE	EA	3
2	27	PA0ZZ	5960-00-879-8174	6EB8	82219	ELECTRON TUBE	EA	1
2	28	PA0ZZ	5960-00-854-8468	6AZ8	49671	ELECTRON TUBE	EA	3
2	29	PA0ZZ	5960-00-179-4446	12AT7	86684	ELECTRON TUBE	EA	2
2	30	PA0ZZ	5960-00-985-8987	6DC6	02735	ELECTRON TUBE	EA	1
2	31	PAFZZ	5935-00-847-6803	3501FP	82389	JACK, TELEPHONE	EA	20
2	32	XDFZZ	5310-00-680-5391	1214-05	78189	WASHER, LOCK	EA	31
2	33	PADZZ		609-1215-001	13499	CONNECTOR, PLUG, JUMPER	EA	1
2	34	PAFZZ	5910-00-822-5683	36C175A	56289	CAPACITOR, FIXED, CERAMIC	EA	40
2	35	PAFZZ	5905-00-088-2136	376-7206-000	71450	RESISTOR, VARIABLE	EA	1
2	36	XDFZZ		P313-0061-000	77250	NUT, PLAIN, HEXAGON	EA	1
2	37	PAFZZ	5820-00-953-0933	544-9695-000	13499	PULLEY	EA	1
2	38	PAFZZ	5820-00-974-3137	544-9709-002	13499	SHAFT, SWITCH	EA	1
2	39	XDFZZ	5365-00-282-0782	5100-25C	79136	RING, RETAINING	EA	1
2	40	XDFZZ	5310-00-276-2766	310-0061-000	79807	WASHER, FLAT	EA	1
2	41	PAFZZ	5935-00-259-0337	59-412-1000	02660	SOCKET, ELECTRON TUBE	EA	11

SECTION II. REPAIR PARTS LIST (CONTINUED)

(1) ILLUSTRATION		(2)	(3)	(4)	(5)	(6)	(7)	(8)
(A) FIG NO.	(B) ITEM NO.	SMR CODE	NATIONAL STOCK NUMBER	PART NUMBER	FSCM	DESCRIPTION USABLE ON CODE	UNIT OF MEAS	QTY INCL IN UNIT
2	42	XDFZZ	5305-00-637-5884	P343-0285-000	77250	SCREW, MACHINE	EA	40
2	43	XDFZZ	5940-00-847-3138	2104-04-01-2520N	78189	TERMINAL LUG	EA	32
2	44	XDFZZ	5310-00-616-3554	MS35335-29	96906	WASHER LOCK	EA	43
2	45	XDFZZ	5310-00-833-5854	P313-0051-000	77250	NUT, PLAIN, HEXAGON	EA	23
2	46	PAFZZ	5935-00-222-9828	TS103P01	81349	SOCKET, ELECTRON TUBE	EA	5
2	47	XDFZZ	5305-00-469-6033	P343-0286-000	77250	SCREW, MACHINE	EA	8
2	48	PAFZZ	5940-00-061-0050	RTMT16M	91663	TERMINAL, STUD	EA	4
2	49	PAFZZ	5935-00-132-2405	TS102P01	81349	SOCKET, ELECTRON TUBE	EA	1
2	50	PAFZZ	5935-00-842-3858	168-013-1000	02660	SOCKET, ELECTRON TUBE	EA	2
2	51	XDFZZ	5310-00-815-4847	P313-0140-000	77250	NUT, PLAIN, HEXAGON	EA	5
2	52	XDFZZ	5305-00-059-8249	P343-0329-000	77250	SCREW, MACHINE	EA	4
2	53	XDFZZ	5940-00-156-7344	2104-06-02-2520N	78189	TERMINAL, LUG	EA	3
2	54	XDFZZ	5310-00-184-8977	MS35338-98	96906	WASHER, SPRING TENSION	EA	18
2	55	XDFZZ		542-5476-002	13499	SHIELD, ELECTRON TUBE SOCKET	EA	3
2	56	PAFZZ	5960-00-302-5754	502-1427-002	13499	SHIELD, ELECTRON TUBE SOCKET	EA	1
2	57	PAFZZ	5960-00-860-7710	M24251-6-5	81349	SHIELD, ELECTRON TUBE	EA	4
2	58	PAFZZ	5960-00-860-7709	M24251-6-2	81349	SHIELD, ELECTRON TUBE	EA	1
2	59	PAFZZ	5935-00-581-6941	TS0205C01	81349	SOCKET, CRYSTAL	EA	1
2	60	XDFZZ	5310-00-934-9740	P313-0050-000	77250	NUT, PLAIN, HEXAGON	EA	6
2	61	XDFZZ	5305-00-052-5948	P342-0147-000	77250	SCREW, MACHINE	EA	1
2	62	XDFZZ	5310-00-551-9286	302-0023-000	05284	WASHER, NONMETALLIC	EA	4
2	63	XDFZZ	5310-00-316-9040	310-0053-000	79807	WASHER, FIAT	EA	2
2	64	PAFZZ	5935-00-259-2034	201-11-01-018	71785	JACK, TELEPHONE	EA	2
2	65	XDFZZ		R3472X5-32CADPL	12014	RIVET, TUBULAR	EA	4
2	66	PAFZZ	5910-00-064-4626	PD52414	72136	CAPACITOR, VARIABLE, MICA DIELECTRIC	EA	3
2	67	PAFZZ		PD52313	72136	CAPACITOR, VARIABLE, MICA DIELECTRIC	EA	1
2	68	XDFZZ	5310-00-721-5860	1712-00	78189	WASHER, LOCK	EA	4
2	69	PAFZZ	5940-00-192-9962	1529A	71785	TERMINAL BOARD, STRIP	EA	1
2	70	PAFZZ	5945-00-950-5572	KR2565-1	77342	RELAY	EA	1
2	71	PAFZZ	5940-00-648-3092	506-7848-002	13499	COIL, RF	EA	1
2	72	XDFZZ	5305-00-059-8248	P343-0328-000	77250	SCREW, MACHINE	EA	17
2	73	XDFZZ		303-3030-000	79807	WASHER, NONMETALLIC	EA	2
2	74	PAFZZ	5930-00-977-3469	88130CK	76854	SWITCH SECTION, ROTARY	EA	1
2	75	PAFZZ	5930-00-977-3468	88128CK	76854	SWITCH SECTION, ROTARY	EA	1
2	76	PAFZZ	5950-00-856-6283	X083	81815	TRANSFORMER, I.F.	EA	1
2	77	PAFZZ	5950-00-856-6369	X004	81815	COIL, I.F.	EA	1
2	78	PAFZZ	5910-00-985-3870	D29413	56289	CAPACITOR, FIXED, ELECTROLYTIC	EA	1
2	79	PAFZZ	5905-00-110-0196	RCR20G102KS	81349	RESISTOR, FIXED	EA	12
2	80	PAFZZ	5905-00-141-0742	RCR07G181KS	81349	RESISTOR, FIXED	EA	5
2	81	PAFZZ	5930-740-8600	22698-6MLW	82104	SWITCH SECTION ROTARY	EA	1
2	82	XDFZZ	5310-00-208-3786	P313-0132-000	77250	NUT, PLAIN, HEXAGON	EA	2

SECTION II. REPAIR PARTS LIST (CONTINUED)

(1) ILLUSTRATION		(2)	(3)	(4)	(5)	(6)	(7)	(8)
(A) FIG NO.	(B) ITEM NO.	SMR CODE	NATIONAL STOCK NUMBER	PART NUMBER	FSCM	DESCRIPTION USABLE ON CODE	UNIT OF MEAS	QTY INCL IN UNIT
2	83	XDFZZ	5310-00-933-8118	310-0278-000	70318	WASHER, LOCK	EA	2
2	84	PAFZZ	5905-00-088-2137	BA811-2896	71590	RESISTOR, VARIABLE, COMPOSITION	EA	1
2	85	PAFZZ	5950-00-867-0940	X682-1	81815	TRANSFORMER, I. F.	EA	1
2	86	PAFZZ	5930-00-856-6393	191774-23	76854	SWITCH SECTION, ROTARY	EA	1
2	87	PAFZZ	5905-00-088-5663	BA812-1211	71590	RESISTOR, VARIABLE, SWITCH	EA	1
2	88	PAFZZ	5940-00-259-8457	RTMT12M	91663	TERMINAL, STUD	EA	6
2	89	XDFZZ	5305-00-206-1270	P343-0284-000	77250	SCREW, MACHINE	EA	5
2	90	PAFZZ	5950-00-856-6284	X094-1	81815	TRANSFORMER, I. F.	EA	1
2	91	PAFZZ	5910-00-984-8678	327029HM0102K	72982	CAPACITOR, FIXED, CERAMIC DIELECTRIC	EA	1
2	92	XDFZZ	5310-00-957-1297	P313-0149-000	77250	NUT, PLAIN, HEXAGON	EA	6
2	93	XDFZZ	5940-00-665-5592	4012HT	77147	TERMINAL, LUG	EA	1
2	94	PAFZZ	5905-00-952-0749	WR5453	71450	RESISTOR, VARIABLE, COMPOSITION	EA	3
2	95	XDFZZ	5310-00-935-8963	P334-0253-000	77250	NUT, PLAIN, HEXAGON	EA	5
2	96	PAFZZ	5950-00-856-6275	X239	81815	SUPPRESSOR, PARASITIC	EA	1
2	97	XDFZZ	5310-00-184-8996	MS35338-97	96906	WASHER, SPRING TENSION	EA	7
2	98	PAFZZ	5910-00-794-9073	160-104-3	71313	CAPACITOR, VARIABLE, AIR DIELECTRIC	EA	1
2	99	PAFZZ	5910-00-794-9064	SK100665	72982	CAPACITOR, FIXED, MICA DIELECTRIC	EA	1
2	100	PAFZZ	5940-00-192-9962	332-14-02-001	71785	TERMINAL BOARD, STRIP	EA	2
2	101	PAFZZ	5910-00-954-5496	CM05ED200J03	81349	CAPACITOR, FIXED, MICA DIELECTRIC	EA	2
2	102	PAFZZ	5910-00-871-5935	557006C0P039R	72982	CAPACITOR, VARIABLE, CERAMIC DIELECTRIC	EA	6
2	103	XDFZZ		330-0731-000	45722	SCREW, TAPPING THREAD	EA	52
2	104	PAFZZ	5910-00-649-5094	557-018-1-5-7A	72982	CAPACITOR, VARIABLE, CERAMIC DIELECTRIC	EA	3
2	105	PAFZZ	5910-00-089-3496	DM15E510K500WV 4CR	72136	CAPACITOR, FIXED, MICA DIELECTRIC	EA	1
2	106	PAFZZ	5910-00-921-0403	557006U2P034R	72982	CAPACITOR, VARIABLE, CERAMIC DIELECTRIC	EA	14
2	107	PAFZZ	5910-00-995-0614	CM05FD221J03	81349	CAPACITOR, FIXED, MICA DIELECTRIC	EA	3
2	108	PAFZZ	5910-00-702-8057	CM05FD331G03	81349	CAPACITOR FIXED, MICA DIELECTRIC	EA	1
2	109	PAFZZ	5910-00-666-7992	557-018A3-0-12PF	72982	CAPACITOR, VARIABLE, CERAMIC DIELECTRIC	EA	1
2	110	PAFZZ	5910-00-954-5508	CM05FD241G03	81349	CAPACITOR, FIXED, MICA DIELECTRIC	EA	1
2	111	PAFZZ	5910-00-952-7046	DM15E560K500WV 4CR	72136	CAPACITOR, FIXED, MICA DIELECTRIC	EA	1
2	112	XDFZZ	5940-00-665-5764	ST1050-34	95238	TERMINAL, STUD	EA	1
2	113	PAFZZ	5910-00-764-9574	CM05FD361G03	81349	CAPACITOR, FIXED, MICA DIELECTRIC	EA	1
2	114	PAFZZ	5910-00-732-2210	CM05FD131J03	81349	CAPACITOR, FIXED, MICA DIELECTRIC	EA	1
2	115	PAFZZ	5910-00-051-4612	CM05ED220J03	81349	CAPACITOR, FIXED, MICA DIELECTRIC	EA	1
2	116	PAFZZ	5910-00-954-5508	CM05FD241J03	81349	CAPACITOR, FIXED, MICA DIELECTRIC	EA	1
2	117	PAFZZ		DM15F121K500WV 4CR	72136	CAPACITOR, FIXED, MICA DIELECTRIC	EA	1
2	118	PAFZZ	5910-00-044-4355	CM05ED470J03	81349	CAPACITOR, FIXED, MICA DIELECTRIC	EA	2
2	119	PAFZZ	5935-00-984-9532	544-2825-002	13499	SOCKET, CRYSTAL	EA	2
2	120	PAFZZ	5310-00-821-1925	540-9045-003	13499	POST, ELECTRICAL-MECHANICAL	EA	3
2	121	XDFZZ	5305-00-763-7827	MS51959-18	96906	SCREW, MACHINE	EA	2

SECTION II. REPAIR PARTS LIST (CONTINUED)

(1) ILLUSTRATION		(2)	(3)	(4)	(5)	(6)	(7)	(8)
(A) FIG NO.	(B) ITEM NO.	SMR CODE	NATIONAL STOCK NUMBER	PART NUMBER	FSCM	DESCRIPTION USABLE ON CODE	UNIT OF MEAS	QTY INCL IN UNIT
2	122	PA0ZZ	5955-00-901-1995	290-9028-000	32897	CRYSTAL UNIT, QUARTZ	EA	1
2	123	PA0ZZ	5955-00-901-1991	290-9009-000	32897	CRYSTAL UNIT, QUARTZ	EA	1
2	124	PA0ZZ		290-9010-000	32897	CRYSTAL UNIT, QUARTZ	EA	1
2	125	PA0ZZ	5955-00-901-1993	290-9011-000	32897	CRYSTAL UNIT, QUARTZ	EA	1
2	126	PA0ZZ	5955-00-901-1994	290-9027-000	32897	CRYSTAL UNIT, QUARTZ	EA	1
2	127	PA0ZZ		290-9062-000	32897	CRYSTAL UNIT, QUARTZ	EA	1
2	128	PA0ZZ	5955-00-088-1995	290-9063-000	13499	CRYSTAL UNIT, QUARTZ	EA	1
2	129	PA0ZZ	5955-00-898-3453	290-9098-000	32897	CRYSTAL UNIT, QUARTZ	EA	1
2	130	PA0ZZ	5955-00-901-2947	290-9099-000	32897	CRYSTAL UNIT, QUARTZ	EA	1
2	131	PA0ZZ	5955-00-901-2948	290-9201-000	32897	CRYSTAL UNIT, QUARTZ	EA	1
2	132	PA0ZZ	5955-00-901-2000	290-9066-000	32897	CRYSTAL UNIT, QUARTZ	EA	1
2	133	PA0ZZ	5955-00-901-1998	290-9097-000	32897	CRYSTAL UNIT, QUARTZ	EA	1
2	134	PAFZZ	5820-00-974-3138	544-9711-002	13499	SHAFT, BANDSWITCH	EA	1
2	135	PAFZZ	5820-00-974-3125	546-7829-004	13499	DIAL ASSEMBLY, KEYED	EA	1
2	136	PAFZZ	5935-00-064-3839	86CP11-1008	02660	CONNECTOR, PLUG, ELECTRICAL	EA	1
2	137	XDFZZ	5305-00-770-2579	P330-2292-000	77250	SCREW, MACHINE	EA	4
2	138	XDFZZ	5820-00-974-5087	546-8005-002	13499	SPACER, SLEEVE	EA	4
2	139	XDFZZ	5310-00-934-9748	MS35649-244	96906	NUT, PLAIN, HEXAGON	EA	4
2	140	PAFZZ	5935-00-881-6538	86CP9-1003	02660	CONNECTOR, PLUG, ELECTRICAL	EA	1
2	141	PAFZZ	5905-00-088-2135	376-7202-000	71450	RESISTOR, VARIABLE, COMPOSITION	EA	2
2	142	PAFZZ	5905-00-900-0431	RCR20G473KS	81349	RESISTOR, FIXED, COMPOSITION	EA	4
2	143	PAFZZ	5905-00-957-9784	WR5454	71450	RESISTOR, VARIABLE, COMPOSITION	EA	1
2	144	PAFZZ	5905-01-026-2157	WR5451	71450	RESISTOR, VARIABLE, COMPOSITION	EA	1
2	145	PAFZZ	5905-00-108-6922	RCR20G151KS	81349	RESISTOR, FIXED, COMPOSITION	EA	3
2	146	PAFZZ	5310-00-754-3071	540-9053-003	13499	POST, ELECTRICAL-MECHANICAL	EA	2
2	147	XDFZZ		P319-0043-000	77250	SCREW, MACHINE	EA	2
2	148	XDFZZ	5310-00-209-0960	1704-03	78189	WASHER, LOCK	EA	2
2	149	PA0ZZ	6240-00-155-8706	MS15571-2	96906	LAMP, INCANDESCENT	EA	1
2	150	PAFZZ	6250-00-233-5086	4159-043	72765	LAMPHOLDER	EA	1
2	151	PAFZZ	5915-01-016-8275	526-9427-000	13499	FILTER, MECHANICAL	EA	1
2	152	PAFZZ		T50411	72136	CAPACITOR, VARIABLE, MICA DIELECTRIC	EA	1
2	153	PAFZZ	5910-00-838-9421	40C73A1	56289	CAPACITOR, FIXED, CERAMIC DIELECTRIC	EA	18
2	154	PAFZZ	5910-00-556-1425	33C2	56289	CAPACITOR, FIXED, CERAMIC DIELECTRIC	EA	7
2	155	PAFZZ	5950-00-725-6103	18-257	09250	COIL, RADIO FREQUENCY	EA	2
2	156	XDFZZ	5820-00-974-3121	543-8062-002	13499	BAR, SUPPORT	EA	1
2	157	XDFZZ	5305-00-844-9888	330-0735-000	45722	SCREW, SELF-TAPPING	EA	4
2	158	XDFZZ		544-9720-003	13499	BRACKET, FRONT	EA	1
2	159	PAFZZ	5820-00-974-3134	544-9705-002	13499	SHAFT, SUN	EA	1
2	160	PAFZZ	3120-00-957-6666	A238-5MILL6085A	70417	BEARING, SLEEVE	EA	3
2	161	XDFZZ		P343-0291-000	77250	SCREW, MACHINE	EA	2
2	162	XDFZZ	5310-00 688-0137	500-1073-003	13499	WASHER, FLAT	EA	1

SECTION II. REPAIR PARTS LIST (CONTINUED)

(1) ILLUSTRATION		(2)	(3)	(4)	(5)	(6)	(7)	(8)
(A) FIG NO.	(B) ITEM NO.	SMR CODE	NATIONAL STOCK NUMBER	PART NUMBER	FSCM	DESCRIPTION USABLE ON CODE	UNIT OF MEAS	QTY INCL IN UNIT
2	163	XDFZZ		330-0733-000	45722	SCREW, SELF-TAPPING	EA	2
2	164	PAFZZ	3020-00-979-5367	543-8087-002	13499	PULLEY, IDLER	EA	2
2	165	XDFZZ	5305-00-054-6674	MS51957-49	96906	SCREW, MACHINE	EA	2
2	166	XDFZZ	5365-00-087-6663	543-8065-002	13499	SPACER, POST	EA	2
2	167	XDFZZ	5310-00-934-9759	MS35649-284	96906	NUT, PLAIN, HEXAGON	EA	2
2	168	XDFZZ	5820-00-974-3124	543-8030-000	13499	TABLE, SLUG	EA	1
2	169	XDFZZ		544-9721-003	13499	BRACKET, REAR	EA	1
2	170	PAFZZ	3110-00-183-9175	1-8SSBALL	27545	BEARING, BALL	EA	1
2	171	XDFZZ	5820-00-974-3124	328-0028-000	08664	SETSCREW	EA	1
2	172	XDFZZ	5820-00-974-3128	97NM02	72962	NUT, SELF-LOCKING	EA	1
2	173	PAFZZ		309-5300-000	27545	BEARING, BALL	EA	4
2	174	XDFZZ	5820-00-974-3140	546-2130-002	13499	STOP, THREADED	EA	1
2	175	PAFZZ	5820-00-974-3133	544-9722-003	13499	SHAFT, PLANETARY	EA	1
2	176	XDFZZ	5820-00-974-3128	543-8103-002	13499	SPRING, SLUG RACK	EA	2
2	177	XDFZZ	5305-00-059-8226	P343-0297-000	77250	SCREW, MACHINE	EA	2
2	178	XDFZZ	5310-00-543-4652	MS35333-69	96906	WASHER, LOCK	EA	2
2	179	XDFZZ	5305-00-207-7468	P343-0289-000	77250	SCREW, MACHINE	EA	1
2	180	XDFZZ	5310-00-268-6116	P313-0156-000	77250	NUT, PLAIN HEXAGON	EA	7
2	181	XDFZZ	5950-00-087-7324	288-2509-000	13499	CORE, FERRITE	EA	5
2	182	XDFZZ	5820-00-974-3130	544-3139-002	13499	SPRING, LONG	EA	1
2	183	XDFZZ	5820-00-974-3132	544-9719-003	13499	BRACKET, POWER AMPLIFIER	EA	1
2	184	XDFZZ	5310-00-591-3416	310-0054-000	79807	WASHER, FLAT	EA	5
2	185	PAFZZ	5910-00-088-2026	9404-11-20026	71313	CAPACITOR, VARIABLE, AIR DIELECTRIC	EA	1
2	186	PAFZZ	5910-00-088-3869	920-0138-000	80486	CAPACITOR, VARIABLE, AIR DIELECTRIC	EA	1
2	187	XDFZZ	5305-00-054-6666	P325-0062-000	77250	SCREW, MACHINE	EA	3
2	188	XDFZZ	5310-00-584-7139	310-0055-000	79807	WASHER, FLAT	EA	5
2	189	PAFZZ	5950-00-642-5951	240-0194-000	06560	COIL, RADIO FREQUENCY	EA	2
2	190	PAFZZ	3020-00-950-9993	543-7739-000	13499	PULLEY, SOLDERED	EA	2
2	191	XDFZZ	5305-00-145-0987	328-0512-010	08664	SETSCREW	EA	4
2	192	XDFZZ	5820-00-450-4796	544-3146-003	13499	COVER, POWER AMPLIFIER	EA	1
2	193	XDFZZ	4010-00-171-3556	432-1009-000	94452	WIRE STRAND, STEEL-DIAL CABLE	EA	1
2	194	XDFZZ	3010-00-528-9944	39003	76487	COUPLING	EA	1
2	195	XDFZZ		6-32X1-8 6SPL INE4165	08864	SETSCREW	EA	2
2	196	PAFZZ	5820-00-974-3135	544-9706-002	13499	SHAFT, TRIMMING	EA	1
2	197	PAFZZ	5820-00-974-3136	544-9707-002	13499	SHAFT, TUNING	EA	1
2	198	PAFZZ	5950-00-087-7318	544-9701-000	13499	COIL, RADIO FREQUENCY	EA	1
2	199	PAFZZ	5915-00-088-0814	544-3125-002	13499	SUPPRESSOR, PARASITIC	EA	2
2	200	PAOZZ		61468	94998	ELECTRON TUBE	EA	2
2	201	PAFZZ	5960-00-856-8336	M24251-6-6	81349	SHIELD, ELECTRON TUBE	EA	1
2	202	PAOZZ	5960-00-615-0243	6CL6	86684	ELECTRON TUBE	EA	1

SECTION II. REPAIR PARTS LIST (CONTINUED)

(1) ILLUSTRATION		(2)	(3)	(4)	(5)	(6)	(7)	(8)
(A) FIG NO.	(B) ITEM NO.	SMR CODE	NATIONAL STOCK NUMBER	PART NUMBER	FSCM	DESCRIPTION USABLE ON CODE	UNIT OF MEAS	QTY INCL IN UNIT
2	203	PAFZZ	5910-01-026-2180	854-15N	71590	CAPACITOR, FIXED, CERAMIC DIELECTRIC	EA	1
2	204	PAFZZ	5905-00-106-9353	RCR32G474JS	81349	RESISTOR, FIXED, COMPOSITION	EA	1
2	205	PAFZZ		858W5T2KV1KPF PORM20PCT	72982	CAPACITOR, FIXED, CERAMIC DIELECTRIC	EA	4
2	206	PAFZZ	5950-00-087-7317	543-8024-000	13499	COIL, RADIO FREQUENCY	EA	1
2	207	XDFZZ	5305-00-240-0518	P343-0307-000	77250	SCREW MACHINE	EA	2
2	208	XDFZZ	5310-00-559-8408	302-0030-000	05284	WASHER, NONMETALLIC	EA	2
2	209	PAFZZ	5950-00-228-4234	34103	76487	COIL, RADIO FREQUENCY	EA	1
2	210	PAFZZ	6210-00-075-2502	515-0325	72619	SHIELD, LAMP	EA	1
2	211	PAFZZ	5905-00-116-8554	RCR07G105KS	81349	RESISTOR, FIXED, COMPOSITION	EA	13
2	212	PAFZZ	5910-00-984-7588	DM15F101K500W V4CR	72136	CAPACITOR, FIXED, MICA DIELECTRIC	EA	3
2	213	PAFZZ	5950-00-706-9463	4422-10-38	06560	COIL, RADIO FREQUENCY	EA	1
2	214	PAFZZ	5905-00-185-8516	RCR42G103KS	81349	RESISTOR, FIXED, COMPOSITION	EA	1
2	215	PAFZZ		6H12	82893	TERMINAL, TURRET	EA	10
2	216	PAFZZ	5905-00-935-8545	RCR20G183KS	81349	RESISTOR, FIXED, COMPOSITION	EA	3
2	217	PAFZZ	5905-00-110-0993	RCR20G123KS	81349	RESISTOR, FIXED, COMPOSITION	EA	2
2	218	PAFZZ	5905-00-114-5361	RCR20G121KS	81349	RESISTOR, FIXED, COMPOSITION	EA	3
2	219	PAFZZ	5950-00-070-7637	MS90540-07	96906	COIL, RADIO FREQUENCY	EA	3
2	220	PAFZZ	5910-00-080-9560	913-3829-000	71590	CAPACITOR, FIXED, CERAMIC, DUAL	EA	20
2	221	PAFZZ	5910-00-957-2054	DM15E330K500W V4CR	72136	CAPACITOR, FIXED, MICA DIELECTRIC	EA	1
2	222	PAFZZ	5905-00-105-7767	RCR07G474KS	81349	RESISTOR, FIXED, COMPOSITION	EA	4
2	223	PAFZZ	5905-00-110-0388	RCR07G104KS	81349	RESISTOR, FIXED, COMPOSITION	EA	6
2	224	PAFZZ	5905-00-577-3993	RCR07G684KS	81349	RESISTOR, FIXED, COMPOSITION	EA	2
2	225	PAFZZ	5961-00-975-2175	IN458	07263	SEMICONDUCTOR DEVICE, DIODE	EA	3
2	226	PAFZZ	5950-00-994-6600	MS90538-20	96906	COIL, RADIO FREQUENCY	EA	6
2	227	PAFZZ	5910-00-825-0403	2DD63G104XAA	71590	CAPACITOR, FIXED, CERAMIC DIELECTRIC	EA	7
2	228	PAFZZ	5910-00-929-7374	825-213X5V0104Z	72982	CAPACITOR, FIXED, CERAMIC DIELECTRIC	EA	2
2	229	PAFZZ	5950-00-875-4596	543-8123-002	13499	COIL, RADIO FREQUENCY	EA	1
2	230	PAFZZ	5905-00-141-1168	RCR20G222KS	81349	RESISTOR, FIXED, COMPOSITION	EA	4
2	231	PAFZZ	5940-00-238-9758	2A1D815	92825	TERMINAL, STANDOFF, INSULATED	EA	4
2	232	PAFZZ	5950-00-856-6153	543-8028-002	13499	COIL, RADIO, FREQUENCY	EA	1
2	233	PAFZZ	5910-00-893-0196	CM04FD111G03	81349	CAPACITOR, FIXED, MICA DIELECTRIC	EA	1
2	234	PAFZZ	5930-00-977-3470	88216CK	76854	SWITCH SECTION, ROTARY	EA	1
2	235	PAFZZ	5905-00-106-9344	RCR20G101KS	81349	RESISTOR, FIXED, COMPOSITION	EA	7
2	236	PAFZZ	5910-00-902-0335	CM05CD100D03	81349	CAPACITOR, FIXED, MICA DIELECTRIC	EA	1
2	237	PAFZZ	5910-00-902-0335	DM15C100K500W V4CR	72136	CAPACITOR, FIXED, MICA DIELECTRIC	EA	5
2	238	PAFZZ	5905-00-111-4738	RCR20G152KS	81349	RESISTOR, FIXED, COMPOSITION	EA	2
2	239	PAFZZ	5905-00-114-5416	RCR20G274JS	81349	RESISTOR, FIXED, COMPOSITION	EA	2
2	240	PAFZZ	5905-00-141-1071	RCR20G474KS	81349	RESISTOR, FIXED, COMPOSITION	EA	3
2	241	PAFZZ	5910-00-784-0696	41C92	56289	CAPACITOR, FIXED, CERAMIC DIELECTRIC	EA	7

SECTION II. REPAIR PARTS LIST (CONTINUED)

(1) ILLUSTRATION		(2)	(3)	(4)	(5)	(6)	(7)	(8)
(A) FIG NO.	(B) ITEM NO.	SMR CODE	NATIONAL STOCK NUMBER	PART NUMBER	FSCM	DESCRIPTION <i>USABLE ON CODE</i>	UNIT OF MEAS	QTY INCL IN UNIT
2	242	PAFZZ	5910-00-807-1539	CC20CH060D	81349	CAPACITOR, FIXED, CERAMIC DIELECTRIC	EA	2
2	243	PAFZZ	5905-00-110-7622	RCR07G682KS	81349	RESISTOR, FIXED, COMPOSITION	EA	1
2	244	PAFZZ	5905-00-400-4482	RCR32G333JS	81349	RESISTOR, FIXED, COMPOSITION	EA	1
2	245	PAFZZ	5915-00-087-4928	544-9698-000	13499	SUPPRESSOR, PARASITIC	EA	1
2	246	PAFZZ	5905-00-106-9345	RCR20G683KS	81349	RESISTOR, FIXED, COMPOSITION	EA	3
2	247	PAFZZ		VVC445	16352	CAPACITOR, VARIABLE, VOLTAGE SENSITIVE	EA	1
2	248	PAFZZ	5910-00-936-7372	DM15C120K500W V4CR	72136	CAPACITOR, FIXED, MICA DIELECTRIC	EA	1
2	249	PAFZZ	5930-00-759-5151	196305CK	76854	SWITCH SECTION, ROTARY	EA	3
2	250	PAFZZ	5910-00-764-9574	CM05FD361J03	81349	CAPACITOR, FIXED, MICA DIELECTRIC	EA	1
2	251	PAFZZ	5910-00-088-1245	CM05FD271J03	81349	CAPACITOR, FIXED, MICA DIELECTRIC	EA	1
2	252	PAFZZ	5940-00-192-9962	332-1403-165	71785	TERMINAL BOARD, STRIP	EA	4
2	253	PAFZZ	5950-00-875-4595	546-7833-00E	13499	COIL, RADIO FREQUENCY	EA	1
2	254	PAFZZ	5905-00-106-3666	RCR07G103KS	81349	RESISTOR, FIXED, COMPOSITION	EA	2
2	255	PAFZZ	5905-00-111-8372	RCR32G222KS	81349	RESISTOR, FIXED, COMPOSITION	EA	1
2	256	PAFZZ	5905-00-133-0440	RCR07G560KS	81349	RESISTOR, FIXED, COMPOSITION	EA	4
2	257	PAFZZ	5905-00-104-8350	RCR20G221JS	81349	RESISTOR, FIXED, COMPOSITION	EA	3
2	258	PAFZZ	5905-00-244-8258	RCR32G332KS	81349	RESISTOR, FIXED, COMPOSITION	EA	1
2	259	PAFZZ	5905-00-104-8330	RCR20G333KS	81349	RESISTOR, FIXED, COMPOSITION	EA	1
2	260	PAFZZ	5910-00-068-1334	CM05ED430J03	81349	CAPACITOR, FIXED, MICA DIELECTRIC	EA	1
2	261	PAFZZ	5905-00-104-8345	RCR20G560KS	81349	RESISTOR, FIXED, COMPOSITION	EA	1
2	262	PAFZZ	5950-00-087-7300	544-9715-002	13499	TRANSFORMER, RADIO FREQUENCY	EA	1
2	263	PAFZZ	5910-00-655-0591	CC20CJ030D	81349	CAPACITOR, FIXED, CERAMIC DIELECTRIC	EA	1
2	264	PAFZZ	5950-00-106-1273	RCR20G153KS	81349	RESISTOR, FIXED, COMPOSITION	EA	1
2	265	PAFZZ	5905-00-104-5756	RCR20G105JS	81349	RESISTOR, FIXED, COMPOSITION	EA	2
2	266	PAFZZ	5905-00-104-8335	RCR20G124KS	81349	RESISTOR, FIXED, COMPOSITION	EA	2
2	267	PAFZZ	5905-00-104-8336	RCR20G104KS	81349	RESISTOR, FIXED, COMPOSITION	EA	6
2	268	PAFZZ	5905-00-114-5393	RCR20G224KS	81349	RESISTOR, FIXED, COMPOSITION	EA	4
2	269	PAFZZ	5910-00-957-9908	CM06 FD511J03	81349	CAPACITOR, FIXED, MICA DIELECTRIC	EA	2
2	270	XDFZZ	5305-00-768-0336	MS51959-17	96906	SCREW, MACHINE	EA	2
2	271	PAFZZ	5930-00-856-6392	22692-414LW1	82104	SWITCH SECTION, ROTARY	EA	1
2	272	PAFZZ	3020-00-950-9994	544-3132-002	13499	PULLEY	EA	1
2	273	PAFZZ	3020-00-540-7640	PV3	06915	PULLEY, IDLER	EA	1
2	274	XDFZZ	5305-00-576-6004	P343-0302-000	77250	SCREW, MACHINE	EA	1
2	275	XDFZZ		503-1236-001	13499	SPACER, SLEEVE	EA	1
2	276	XDFZZ	5310-00-184-8990	MS35338-96	96906	WASHER, SPRING TENSION	EA	1
2	277	PAFZZ	5930-00-759-5150	192796CK	76854	SWITCH SECTION, ROTARY	EA	2
2	278	PAFZZ	5350-00-087-7301	546-7945-003	13499	TRANSFORMER, RADIO FREQUENCY	EA	1
2	279	PAFZZ	5905-00 650-9808	RCR42G682JS	81349	RESISTOR, FIXED, COMPOSITION	EA	1
2	280	PAFZZ	5961-00-897-8326	IN34A	03877	SEMICONDUCTOR DEVICE, DIODE	EA	1
2	281	PAFZZ	5905-00-114-0711	RCR07G472KS	81349	RESISTOR, FIXED, COMPOSITION	EA	1
2	282	PAFZZ	5905-00-111-4727	RCR07G2 72KS	81349	RESISTOR, FIXED, COMPOSITION	EA	1

SECTION II. REPAIR PARTS LIST (CONTINUED)

(1) ILLUSTRATION		(2)	(3)	(4)	(5)	(6)	(7)	(8)
(A) FIG NO.	(B) ITEM NO.	SMR CODE	NATIONAL STOCK NUMBER	PART NUMBER	FSCM	DESCRIPTION USABLE ON CODE	UNIT OF MEAS	QTY INCL IN UNIT
2	283	PAFZZ	5905-00-141-0744	RCR07G562KS	81349	RESISTOR, FIXED, COMPOSITION	EA	1
2	284	XDFZZ	5305-00-763-6963	MS51959-28	96906	SCREW, MACHINE	EA	1
2	285	XDFZZ		310-0007-000	79807	WASHER, FLAT	EA	1
2	286	PAFZZ	5905-00-111-1684	RCR07G155JS	81349	RESISTOR, FIXED, COMPOSITION	EA	1
2	287	PAFZZ	5905-00-126-6693	RCR07G825KS	81349	RESISTOR, FIXED, COMPOSITION	EA	2
2	288	PAFZZ	5905-00-136-8338	RCR42G183KS	81349	RESISTOR, FIXED, COMPOSITION	EA	1
2	289	PAFZZ	5950-00-893-8650	MS90539-15	96906	COIL, RADIO FREQUENCY	EA	3
2	290	PAFZZ	5905-00-135-3973	RCR07G221KS	81349	RESISTOR, FIXED, COMPOSITION	EA	4
2	291	PAFZZ	5905-00-119-3503	RCR07G271KS	81349	RESISTOR, FIXED, COMPOSITION	EA	1
2	292	PAFZZ	5905-00-114-0710	RCR07G331KS	81349	RESISTOR, FIXED, COMPOSITION	EA	1
2	293	PAFZZ	5905-00-120-9154	RCR07G471KS	81349	RESISTOR, FIXED, COMPOSITION	EA	3
2	294	PAFZZ	5905-00-121-9932	RCR07G391KS	81349	RESISTOR, FIXED, COMPOSITION	EA	1
2	295	PAFZZ	5910-00-809-5484	5C13A	56289	CAPACITOR, FIXED, CERAMIC DIELECTRIC	EA	1
2	296	PAFZZ	5905-00-088-2130	PW5-6001-10	07716	RESISTOR, FIXED, WIREWOUND	EA	1
2	297	PAFZZ		LP9A1E683K	01884	CAPACITOR, FIXED, PLASTIC DIELECTRIC	EA	1
2	298	PAFZZ	5905-00-249-3663	RCR42G683KS	81349	RESISTOR, FIXED, COMPOSITION	EA	2
2	299	PAFZZ	5910-00-933-4005	5C11A	56289	CAPACITOR, FIXED, CERAMIC DIELECTRIC	EA	2
2	300	PAFZZ	5905-00-141-0599	RCR20G393KS	81349	RESISTOR, FIXED, COMPOSITION	EA	3
2	301	PAFZZ	5905-00-171-1976	RCR42G123KS	81349	RESISTOR, FIXED, COMPOSITION	EA	2
2	302	PAFZZ	5961-00-905-5083	FA4000	07263	SEMICONDUCTOR, DEVICE DIODE-SET	EA	1
2	303	PAFZZ	5905-00-141-0717	RCR07G473KS	81349	RESISTOR, FIXED, COMPOSITION	EA	4
2	304	PAFZZ	5950-00-704-1993	MS75008-40	96906	COIL, RADIO FREQUENCY	EA	2
2	305	PAFZZ	5905-00-106-1276	RCR32G104KS	81349	RESISTOR, FIXED, COMPOSITION	EA	1
2	306	PAFZZ	5905-00-935-8544	RCR20G181KS	81349	RESISTOR, FIXED, COMPOSITION	EA	1
2	307	PAFZZ	5905-00-104-8334	RCR20G331KS	81349	RESISTOR, FIXED, COMPOSITION	EA	1
2	308	PAFZZ	5905-00-984-6566	HM6821	01121	RESISTOR, FIXED, COMPOSITION	EA	1
2	309	PAFZZ	5905-00-252-1671	RCR07G225KS	81349	RESISTOR, FIXED, COMPOSITION	EA	3
2	310	PAFZZ	5905-00-126-6677	RCR07G335JS	81349	RESISTOR, FIXED, COMPOSITION	EA	1
2	311	PAFZZ	5910-00-995-0614	DM15F21K500W V4CR	72136	CAPACITOR, FIXED, MICA DIELECTRIC	EA	1
2	312	PAFZZ	5905-00-104-8333	RCR20G184KS	81349	RESISTOR, FIXED, COMPOSITION	EA	1
2	313	PAFZZ	5905-00-104-5755	RCR20G100KS	81349	RESISTOR, FIXED, COMPOSITION	EA	1
2	314	PAFZZ	5905-00-435-6374	RCR07G823KS	81349	RESISTOR, FIXED, COMPOSITION	EA	1
2	315	PAFZZ	5910-00-823-1068	44C7A	56289	CAPACITOR, FIXED, CERAMIC DIELECTRIC	EA	8
2	316	PAFZZ	5905-00-033-9830	RCR42G153KS	81349	RESISTOR, FIXED, COMPOSITION	EA	1
2	317	PAFZZ	5905-00-279-2675	RCR42G333KS	81349	RESISTOR, FIXED, COMPOSITION	EA	1
2	318	PAFZZ	5910-00-821-5215	19C372	56289	CAPACITOR, FIXED, CERAMIC DIELECTRIC	EA	5
2	319	PAFZZ	5940-01-026-9164	1545D	71785	TERMINAL BOARD, STRIP	EA	1
2	320	PAFZZ	5910-00-542-7369	D31582	56289	CAPACITOR, FIXED, ELECTROLYTIC	EA	1
2	321	PAFZZ	5910-00-954-5498	CM05FD181J03	81349	CAPACITOR, FIXED, MICA DIELECTRIC	EA	1
2	322	PAFZZ	5905-00-111-4734	RCR20G470KS	81349	RESISTOR, FIXED, COMPOSITION	EA	7

SECTION II. REPAIR PARTS LIST (CONTINUED)

(1) ILLUSTRATION		(2)	(3)	(4)	(5)	(6)	(7)	(8)
(A) FIG NO.	(B) ITEM NO.	SMR CODE	NATIONAL STOCK NUMBER	PART NUMBER	FSCM	DESCRIPTION USABLE ON CODE	UNIT OF MEAS	QTY INCL IN UNIT
2	323	PAFZZ	5905-00-104-8343	RCR32G100KS	81349	RESISTOR, FIXED, COMPOSITION	EA	1
2	324	PAFZZ	5910-00-936-7405	DM15C150K500W V4CR	72136	CAPACITOR, FIXED, MICA DIELECTRIC	EA	2
2	325	PAFZZ	5905-00-106-9351	RCR20G273KS	81349	RESISTOR, FIXED, COMPOSITION	EA	1
2	326	PAFZZ	5905-00-116-8558	RCR20G155JS	81349	RESISTOR, FIXED, COMPOSITION	EA	3
2	327	PAFZZ	5910-00-085-0825	TC65	37942	CAPACITOR, FIXED, ELECTROLYTIC	EA	1
2	328	XDFZZ	5305-00-054-6662	MS51957-17	96906	SCREW, MACHINE	EA	1
2	329	XDFZZ	5310-00-782-1349	310-0045-000	79807	WASHER, FLAT	EA	1
2	330	PAFZZ	5905-00-104-8368	RCR07G470KS	81349	RESISTOR, FIXED, COMPOSITION	EA	3
2	331	PAFZZ	5955-00-978-6349	BL290-8705-000	71034	CRYSTAL UNIT, QUARTZ	EA	1
2	332	PAFZZ	5955-00-984-9535	BL290-8706-000	71034	CRYSTAL UNIT, QUARTZ	EA	1
2	333	PAFZZ	5930-00-856-6277	197029K4	76854	SWITCH, SECTION, ROTARY	EA	1
2	334	PAFZZ	5905-00-104-8352	RCR32G153KS	81349	RESISTOR, FIXED, COMPOSITION	EA	1
2	335	PAFZZ	5905-00-279-2527	RCR42G223KS	81349	RESISTOR, FIXED, COMPOSITION	EA	1
2	336	PAFZZ	5950-01-022-0501	MS75089-15	96906	COIL, RADIO FREQUENCY	EA	1
2	337	PAFZZ	5905-00-141-1116	RCR20G562KS	81349	RESISTOR, FIXED, COMPOSITION	EA	3
2	338	PAFZZ	5905-00-141-1165	RCR20G682KS	81349	RESISTOR, FIXED, COMPOSITION	EA	2
2	339	PAFZZ	5905-00-114-5489	RCR20G823KS	81349	RESISTOR, FIXED, COMPOSITION	EA	2
2	340	PAFZZ	5905-00-509-4836	RCR42G273KS	81349	RESISTOR, FIXED, COMPOSITION	EA	1
2	341	PAFZZ	5905-00-910-9486	710-9000-00	13499	RESISTOR, FIXED, WIREWOUND	EA	1
2	342	PAFZZ	5905-00-345-6298	RCR42G220KS	81349	RESISTOR, FIXED, COMPOSITION	EA	1
2	343	PAFZZ	5905-00-113-4861	RCR07G390KS	81349	RESISTOR, FIXED, COMPOSITION	EA	1
2	344	PAFZZ	5905-00-135-3975	RCR07G680KS	81349	RESISTOR, FIXED, COMPOSITION	EA	1
2	345	PAFZZ	5905-00-104-8363	RCR07G820KS	81349	RESISTOR, FIXED, COMPOSITION	EA	1
2	346	PAFZZ	5905-00-141-1183	RCR07G101KS	81349	RESISTOR, FIXED, COMPOSITION	EA	1
2	347	PAFZZ	5905-00-119-8812	RCR07G121KS	81349	RESISTOR, FIXED, COMPOSITION	EA	1
2	348	PAFZZ	5905-00-119-8811	RCR07G151KS	81349	RESISTOR, FIXED, COMPOSITION	EA	1
2	349	PAFZZ	5910-00-997-5399	DM15F471J300W V4CR	72136	CAPACITOR, FIXED, MICA DIELECTRIC	EA	4
2	350	PAFZZ	5905-00-485-4545	RCR07G334KS	81349	RESISTOR, FIXED, COMPOSITION	EA	2
2	351	PAFZZ	5905-00-119-3504	RCR07G273KS	81349	RESISTOR, FIXED, COMPOSITION	EA	1
2	352	PAFZZ	5905-00-141-0716	RCR20G680KS	81349	RESISTOR, FIXED, COMPOSITION	EA	2
2	353	PAFZZ	5905-00-116-8569	RCR20G821KS	81349	RESISTOR, FIXED, COMPOSITION	EA	1
2	354	PAFZZ	5905-00-247-8733	RCR32G562JS	81349	RESISTOR, FIXED, COMPOSITION	EA	1
2	355	PAFZZ	5910-00-835-1200	331013X5U0501K	72982	CAPACITOR, FIXED, CERAMIC DIELECTRIC	EA	8
2	356	PAFZZ	5905-00-104-8353	RCR32G472KS	81349	RESISTOR, FIXED, COMPOSITION	EA	1
2	357	PAFZZ	5905-00-369-6929	RCR32G473KS	81349	RESISTOR, FIXED, COMPOSITION	EA	1
2	358	PAFZZ	5905-00-141-1118	RCR20G390KS	81349	RESISTOR, FIXED, COMPOSITION	EA	1
2	359	PAFZZ	5905-00-935-8543	RCR20G330KS	81349	RESISTOR, FIXED, COMPOSITION	EA	1
2	360	PAFZZ	5905-00-116-8561	RCR20G270KS	81349	RESISTOR, FIXED, COMPOSITION	EA	1
2	361	PAFZZ	5905-00-111-4743	RCR20G820KS	81349	RESISTOR, FIXED, COMPOSITION	EA	1
2	362	PAFZZ	5905-00-114-5388	RCR20G220KS	81349	RESISTOR, FIXED, COMPOSITION	EA	1

SECTION II. REPAIR PARTS LIST (CONTINUED)

(1) ILLUSTRATION		(2)	(3)	(4)	(5)	(6)	(7)	(8)
(A) FIG NO.	(B) ITEM NO.	SMR CODE	NATIONAL STOCK NUMBER	PART NUMBER	FSCM	DESCRIPTION USABLE ON CODE	UNIT OF MEAS	QTY INCL IN UNIT
2	363	PAFZZ	5910-00-950-4810	D28121	56289	CAPACITOR, FIXED, ELECTROLYTIC	EA	1
2	364	PAFZZ	5905-00-111-4733	RCR20G624JS	81349	RESISTOR, FIXED, COMPOSITION	EA	1
2	365	PAFZZ	5905-00-195-6754	RCR42G473KS	81349	RESISTOR, FIXED, COMPOSITION	EA	1
2	366	PAFZZ	5961-00-883-4798	IN1490	81483	SEMICONDUCTOR, DEVICE, DIODE	EA	2
2	367	PAFZZ	5310-00-684-9762	540-9448-003	13499	POST, ELECTRICAL-MECHANICAL	EA	2
2	368	PAFZZ	5905-00-141-0595	RCR20G472KS	81349	RESISTOR, FIXED, COMPOSITION	EA	2
2	369	PAFZZ	5935-00-823-6962	30055-20	02288	SOCKET, RELAY	EA	1
2	370	XDFZZ	5305-00-059-8229	P343-0300-000	77250	SCREW, MACHINE	EA	2
2	371	XDFZZ	5310-00-297-3339	310-6320-000	79807	WASHER, FLAT	EA	4
2	372	PAFZZ	5945-00-027-0723	T163X97	02288	RELAY, ARMATURE	EA	1
2	373	PAFZZ	5935-00-830-6348	30055-2	02288	SOCKET, RELAY	EA	1
2	374	PAFZZ	5945-00-027-0721	970-2439-010	02288	RELAY, ARMATURE	EA	1
2	375	PAFZZ	5910-00-797-4909	33C58	56289	CAPACITOR, FIXED, CERAMIC DIELECTRIC	EA	1
2	376	PAFZZ	5905-00-114-5456	RCR20G684KS	81349	RESISTOR, FIXED, COMPOSITION	EA	1
2	377	PAFZZ	5950-00-856-6285	37859	73386	TRANSFORMER, AUDIO OUTPUT	EA	1
2	378	PAFZZ	5950-00-964-7450	LT4K039	81349	COIL, RADIO FREQUENCY	EA	1
2	379	PAFZZ	5905-00-245-8695	RCR32G680KS	81349	RESISTOR, FIXED, COMPOSITION	EA	1
2	380	PAFZZ	5910-00-804-7088	2DDH63N103M	71590	CAPACITOR, FIXED, CERAMIC DIELECTRIC	EA	2
2	381	PAFZZ	5945-00-066-0661	30040-3	02288	RETAINER, SOCKET, RELAY	EA	1
2	382	PAFZZ	5340-00-792-9681	30040-2	02288	RETAINER, SOCKET, RELAY	EA	1
2	383	PAFZZ	5940-00-901-1405	G2619	21242	TERMINAL, STUD	EA	4
2	384	PAFZZ	5935-00-940-3165	22-16-3	81073	SOCKET, FILTER	EA	2
2	385	PAFZZ	5905-00-910-9485	PW7-15000-10PCT	07716	RESISTOR, FIXED, WIREWOUND	EA	1
2	386	PAFZZ	5905-00-421-0623	RCR20G120JS	81349	RESISTOR, FIXED, COMPOSITION	EA	6
2	387	PAFZZ	5940-00-192-9962	1520A	71785	TERMINAL BOARD, STRIP	EA	1
2	388	PAFZZ	5950-00-645-7431	9348	24226	COIL, RADIO FREQUENCY	EA	1
2	389	PAFZZ	5950-00-079-6045	240-0186-000	06560	COIL, RADIO FREQUENCY	EA	1
2	390	PAFZZ	5910-00-805-6630	CC20CK010C	81349	CAPACITOR, FIXED, CERAMIC DIELECTRIC	EA	2
2	391	PAFZZ	5910-00-892-7334	CK61AW222M	81349	CAPACITOR, FIXED, CERAMIC DIELECTRIC	EA	1
2	392	PAFZZ	5910-00-068-1332	CM05ED390J03	81349	CAPACITOR, FIXED, MICA DIELECTRIC	EA	2
2	393	PAFZZ	5950-00-875-4597	544-9700-000	13499	COIL, RADIO FREQUENCY	EA	1
2	394	PAFZZ	5910-00-804-7566	327-029XST0102Z	72982	CAPACITOR, FIXED, CERAMIC DIELECTRIC	EA	5
2	395	PAFZZ	5905-00-228-6084	RCR32G123JS	81349	RESISTOR, FIXED, COMPOSITION	EA	1
2	396	PAFZZ	5950-00-875-4598	544-9699-000	13499	COIL, RADIO FREQUENCY	EA	2
2	397	PAFZZ	5915-00-950-3454	548-8217-000	13499	SUPPRESSOR, PARASITIC	EA	2
2	398	PAFZZ	5940-00-192-9962	1532A	71785	TERMINAL BOARD, STRIP	EA	1
2	399	PAFZZ	5905-00-434-2023	RCR42G821KS	81349	RESISTOR, FIXED, COMPOSITION	EA	1
2	400	PAFZZ	5940-00-725-3240	DP234-258	21242	TERMINAL, STUD	EA	2
2	401	PAFZZ	5905-00-141-0600	RCR20G822KS	81349	RESISTOR, FIXED, COMPOSITION	EA	1
2	402	PAFZZ	5905-00-110-0310	RCR20G392KS	81349	RESISTOR, FIXED, COMPOSITION	EA	1
2	403	PAFZZ	5905-00-104-8348	RCR20G332KS	81349	RESISTOR, FIXED, COMPOSITION	EA	1

SECTION II. REPAIR PARTS LIST (CONTINUED)

TM 11-5820-554-34P-3

(1) ILLUSTRATION		(2)	(3)	(4)	(5)	(6)	(7)	(8)
(A) FIG NO.	(B) ITEM NO.	SMR CODE	NATIONAL STOCK NUMBER	PART NUMBER	FSCM	DESCRIPTION <i>USABLE ON CODE</i>	UNIT OF MEAS	QTY INCL IN UNIT
2	404	PAFZZ	5910-00-950-4811	D29343	56289	CAPACITOR, FIXED, ELECTROLYTIC	EA	1
2	405	PAFZZ	5910-00-957-2054	CM05ED330J03	81349	CAPACITOR, FIXED, MICA DIELECTRIC	EA	1
2	406	PAFZZ	5910-00-957-8578	CM05ED240J03	81349	CAPACITOR, FIXED, MICA DIELECTRIC	EA	1
2	407	PAFZZ	5910-00-067-5697	CM05ED270J03	81349	CAPACITOR, FIXED, MICA DIELECTRIC	EA	1
2	408	PAFZZ	5820-00-974-3123	544-7262-000	13499	CARD, FREQUENCY SELECT	EA	1
2	409	PAFZZ	3020-01-017-6973	545-6002-002	13499	GEAR, SPUR	EA	1
2	410	PAFZZ	3120-00-087-7432	545-6000-002	13499	HUB, IDLER GEAR	EA	1
2	411	XDFZZ		P343-0282-000	77250	SCREW, MACHINE	EA	1
2	412	PAFZZ	5355-00-868-9746	543-8088-002	13499	INDICATOR	EA	1
2	413	PAFZZ	5905-00-088-2134	BA811-2798	71590	RESISTOR, VARIABLE, COMPOSITION	EA	1
2	414	PAFZZ	5820-00-974-3127	543-8042-000	13499	SHAFT ASSEMBLY	EA	1
2	415	XDFZZ		331-7000-000	79807	WASHER, FLAT	EA	3
2	416	PAFZZ	5820-00-974-5191	548-9326-000	13499	SHAFT, TUNING	EA	1
2	417	PAFZZ	5820-00-974-3126	543-8035-000	13499	BUSHING ASSEMBLY	EA	1
2	418	XDFZZ	5310-00-269-6291	8947-151	04009	NUT, PLAIN, HEXAGON	EA	1
2	419	XDFZZ	5365-00-720-8064	MS16624-1025	96906	RING, RETAINING	EA	1
2	420	XDFZZ	5340-00-847-1768	WW19491	10630	WASHER, FLAT	EA	1
2	421	XDFZZ		331-5020-000	79807	WASHER, FLAT	EA	1
2	422	PAFZZ	5310-00-810-8997	540-9049-003	13499	POST, ELECTRICAL-MECHANICAL	EA	1
2	423	PAFFD	5820-00-988-0458	522-1093-000	13499	OSCILLATOR, RADIO FREQUENCY	EA	1

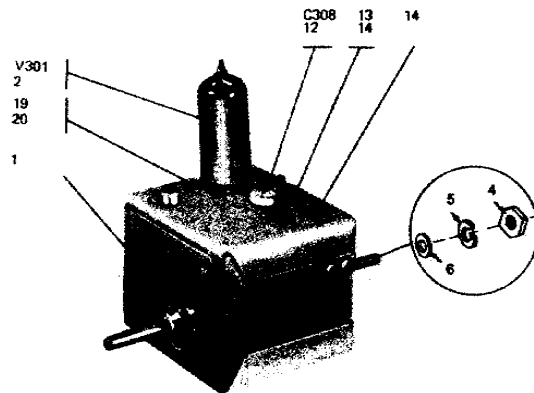
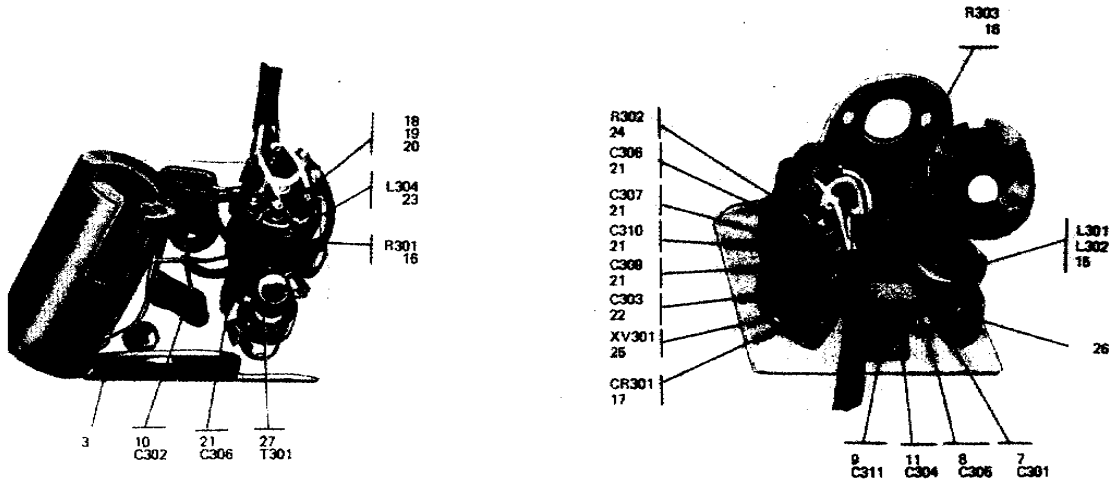

Figure 3. Rf oscillator.

SECTION II. REPAIR PARTS LIST (CONTINUED)

(1) ILLUSTRATION		(2)	(3)	(4)	(5)	(6)	(7)	(8)
(A) FIG NO.	(B) ITEM NO.	SMR CODE	NATIONAL STOCK NUMBER	PART NUMBER	FSCM	DESCRIPTION <i>USABLE ON CODE</i>	UNIT OF MEAS	QTY INCL IN UNIT
3	1	PAFFD	5820-00-988-0458	522-1093-000	13499	GROUP: 0201 OSCILLATOR ASSEMBLY	EA	RE F
3	2	PAOZZ	5960-00-971-8432	7543	86684	OSCILLATOR, RADIO FREQUENCY	EA	1
3	3	XDFZZ		543-7329-002	13499	ELECTRON TUBE	EA	1
3	4	XDFZZ	5310-00-934-9763	P313-0053-000	77250	COYER, OSCILLATOR, REAR	EA	2
3	5	XDFZZ	5310-00-184-8977	MS35338-98	96906	NUT, PLAIN, HEXAGON	EA	2
3	6	XDFZZ	5310 00-209-0306	310-0056-000	79807	WASHER, SPRING TENSION	EA	2
3	7	PAFZZ	5910-00-666-5331	TC20-90	09052	WASHER, FLAT	EA	1
3	8	PAFZZ	5910-00-879-4513	TC100-67	09052	CAPACITOR, FIXED,CERAMIC DIELECTRIC	EA	1
3	9	PAFZZ	5910-00-195-5367	TC10-30	09052	CAPACITOR, FIXED,CERAMIC DIELECTRIC	EA	1
3	10	PAFZZ	5910-00-828-3291	D205FI02F	00853	CAPACITOR, FIXED,MICA DIELECTRIC	EA	1
3	11	PAFZZ	5910-00-069-1295	DM15E201F0300 WV4CR	72136	CAPACITOR, FIXED,MICA DIELECTRIC	EA	1
3	12	PAFZZ	5910-00-543-9552	557-018-5-25A	72982	CAPACITOR, VARIABLE	EA	1
3	13	XDFZZ	5310-00-268-6116	P313-0156-000	77250	NUT, PLAIN, HEXAGON	EA	2
3	14	XDFZZ	5305-00-637-5884	P343-0285-000	77250	SCREW, MACHINE	EA	3
3	15	PAFZZ	5950-00-910-6380	543-7323-000	13499	COIL, RADIO FREQUENCY	EA	1
3	16	PAFZZ	5905-00-104-8336	RCR20G104KS	81349	RESISTOR, FIXED, COMPOSITION	EA	2
3	17	PAFZZ	5961-00-950-6606	1N4454	03508	SEMICONDUCTOR DEVICE, DIODE	EA	1
3	18	PAFZZ	5935-01-024-0418	543-7322-000	13499	SOCKET, ELECTRON TUBE ASSEMBLY	EA	1
3	19	XDFZZ	5305-00-207-7465	P343-0287-000	77250	SCREW, MACHINE	EA	2
3	20	XDFZZ	5310-00-933-8118	310-0278-000	70318	WASHER, FLAT	EA	2
3	21	PAFZZ	5910-00-822-5233	20C109	56289	CAPACITOR, FIXED, CERAMIC DIELECTRIC	EA	4
3	22	PAFZZ	5910-01-026-2170	D205F302F	00853	CAPACITOR, FIXED, MICA DIELECTRIC	EA	1
3	23	PAFZZ	5950-00-910-6361	10200-129	06560	COIL, RADIO FQEQUENCY	EA	1
3	24	PAFZZ	5905-00-114-5489	RCR20G823JS	81349	RESISTOR, FIXED, COMPOSITION	EA	1
3	25	PAFZZ	5935-01-026-2200	114-22-12-018	71785	SOCKET, ELECTRON TUBE	EA	1
3	26	PAFZZ	5940-00-328-9758	2A1DB15	92825	TERMINAL, STUD	EA	1
3	27	PAFZZ	5950-00-910-6367	X006-1	81815	TRANSFORMER, RADIO FREQUENCY	EA	1
BULK		PAFZZ	5820-00-738-2291	820-0171-000	94084	GROUP: 99 BULK MATERIAL SILVER RIBBON	EA	1

SECTION IV. NATIONAL STOCK NUMBER AND PART NUMBER INDEX
NOTE: LATEST NATIONAL STOCK NUMBER ASSIGNMENTS APPEAR AT THE END OF THE INDEX

<u>NATIONAL STOCK NUMBER</u>	<u>FIG. NO.</u>	<u>ITEM NO.</u>	<u>NATIONAL STOCK NUMBER</u>	<u>FIG. NO.</u>	<u>ITEM NO.</u>
3010-00-528-9944	2	194	5305-00-763-7827	2	121
3020-00-540-7640	2	273	5305-00-768-0336	2	270
3020-00-950-9993	2	190	5305-00-770-2579	2	137
3020-00-950-9994	2	272	5305-00-770-2580	2	4
3020-00-979-5367	2	164	5305-00-827-3953	1	3
3020-01-017-6973	2	409	5305-00-844-9888	2	157
3110-00-183-9175	2	170	5305-00-854-7782	2	171
3120-00-087-7432	2	410	5310-00-184-8977	2	54
3120-00-957-6666	2	160	5310-00-184-8977	3	5
4010-00-171-3556	2	193	5310-00-184-8990	2	276
5305-00-052-5948	2	61	5310-00-184-8996	2	97
5305-00-054-6662	2	328	5310-00-208-3786	2	82
5305-00-054-6666	2	187	5310-00-209-0306	3	6
5305-00-054-6674	2	165	5310-00-209 -0960	2	148
5305-00-059-8226	2	177	5310-00-268-6116	2	180
5305-00-059-8229	2	370	5310-00-268-6116	3	13
5305-00-059-8248	2	72	5310-00-269-6291	2	418
5305-00-059-8249	2	52	5310-00-276-2766	2	40
5305-00-145-0987	2	191	5310-00-282-4653	2	22
5305-00-206-1270	2	89	5310-00-297-3339	2	371
5305-00-207-7465	3	19	5310-00-316-9040	2	63
5305-00-207-7468	2	179	5310-00-515-8057	2	172
5305-00-240-0518	2	207	5310-00-543-4652	2	178
5305-00-245-4735	1	7	5310-00-551-9286	2	62
5305-00-469-6033	2	47	5310-00-559-8408	2	208
5305-00-576-6004	2	274	5310-00-584-7139	2	188
5305-00-637-5884	2	42	5310-00-591-3416	2	184
5305-00-637-5884	3	14	5310-00-616-3554	2	44
5305-00-685-7329	2	10	5310-00-680-5391	2	32
5305-00-763-6963	2	284	5310-00-684-9762	2	367

SECTION IV. NATIONAL STOCK NUMBER AND PART NUMBER INDEX (CONTINUED)

<u>NATIONAL STOCK NUMBER</u>	<u>FIG. NO.</u>	<u>ITEM NO.</u>	<u>NATIONAL STOCK NUMBER</u>	<u>FIG. NO.</u>	<u>ITEM NO.</u>
5310-00-688-0137	2	162	5355-00-971-0589	2	7
5310-00-721-5860	2	68	5365-00-087-6663	2	166
5310-00-754-3071	2	146	5365-00-282-0782	2	39
5310-00-782-1349	2	329	5365-00-720-8064	2	419
5310-00-810-8997	2	422	5820-00-082-4080	1	1
5310-00-815-4847	2	51	5820-00-450-4796	2	192
5310-00-821-1925	2	120	5820-00-738-2291	BULK	
5310-00-833-5854	2	45	5820-00-930-8487	2	2
5310-00-883-5931	2	18	5820-00-936-0683	2	3
5310-00-933-8118	3	20	5820-00-953-0933	2	37
5310-00-933-8118	2	83	5820-00-974-3121	2	156
5310-00-934-9740	2	60	5820-00-974-3123	2	408
5310-00-934-9748	2	139	5820-00-974-3124	2	168
5310-00-934-9759	2	167	5820-00-974-3125	2	135
5310-00-934-9763	3	4	5820-00-974-3126	2	417
5310-00-935-8963	2	95	5820-00-974-3127	2	414
5310-00-957-1297	2	92	5820-00-974-3128	2	176
5325-00-281-5088	1	9	5820-00-974-3130	2	182
5325-00-920-0887	1	10	5820-00-974-3132	2	183
			5820-00-974-3133	2	175
5340-00-792-9681	2	382	5820-00-974-3134	2	159
5340-00-847-1768	2	420	5820-00-974-3135	2	196
5355-00-051-6855	2	5	5820-00-974-3136	2	197
5355-00-063-3060	2	9	5820-00-974-3137	2	38
5355-00-063-3061	2	13	5820-00-974-3138	2	134
5355-00-778-4967	2	11	5820-00-974-3140	2	174
5355-00-868-9746	2	412	5820-00-974-5087	2	138
5355-00-878-9454	2	20	5820-00-974-5191	2	416
5355-00-906-1161	1	2	5820-00-988-0458	2	1
5355-00-971-0588	2	6	5820-00-988-0458	2	423

SECTION IV. NATIONAL STOCK NUMBER AND PART NUMBER INDEX (CONTINUED)

<u>NATIONAL STOCK NUMBER</u>	<u>FIG. NO.</u>	<u>ITEM NO.</u>	<u>NATIONAL STOCK NUMBER</u>	<u>FIG. NO.</u>	<u>ITEM NO.</u>
5905-00-033-9830	2	316	5905-00-110-0388	2	223
5905-00-088-2130	2	296	5905-00-110-0993	2	217
5905-00-088-2134	2	413	5905-00-110-7622	2	243
5905-00-088-2135	2	141	5905-00-111-1684	2	286
5905-00-088-2136	2	35	5905-00-111-4727	2	282
5905-00-088-2137	2	84	5905-00-111-4733	2	364
5905-00-088-5663	2	87	5905-00-111-4734	2	322
5905-00-104-5755	2	313	5905-00-111-4738	2	238
5905-00-104-5756	2	265	5905-00-111-4743	2	361
5905-00-104-8330	2	259	5905-00-111-8357	2	23
5905-00-104-8333	2	312	5905-00-111-8372	2	255
5905-00-104-8334	2	307	5905-00-113-4861	2	343
5905-00-104-8335	2	266	5905-00-114-0710	2	292
5905-00-104-8336	2	267	5905-00-114-0711	2	281
5905-00-104-8336	3	16	5905-00-114-5361	2	218
5905-00-104-8343	2	323	5905-00-114-5388	2	362
5905-00-104-8345	2	261	5905-00-114-5393	2	268
5905-00-104-8348	2	403	5905-00-114-5416	2	239
5905-00-104-8350	2	257	5905-00-114-5456	2	376
5905-00-104-8352	2	334	5905-00-114-5489	2	339
5905-00-104-8353	2	356	5905-00-114-5489	3	24
5905-00-104-8363	2	345	5905-00-116-8554	2	211
5905-00-104-8368	2	330	5905-00-116-8558	2	326
5905-00-105-7767	2	222	5905-00-116-8561	2	360
5905-00-106-1276	2	305	5905-00-116-8569	2	353
5905-00-106-3666	2	254	5905-00-119-3503	2	291
5905-00-106-9344	2	235	5905-00-119-3504	2	351
5905 -00-106-9345	2	246	5905-00-119-8811	2	348
5905-00-106-9351	2	325	5905-00-119-8812	2	347
5905-00-106-9353	2	204	5905-00-120-9154	2	293
5905-00-108-6922	2	145	5905-00-121-9932	2	294
5905-00-110-0196	2	79	5905-00-126-6677	2	310
5905-00-110-0310	2	402	5905-00-126-6693	2	287
			5905-00-133-0440	2	256

SECTION IV. NATIONAL STOCK NUMBER AND PART NUMBER INDEX (CONTINUED)

<u>NATIONAL STOCK NUMBER</u>	<u>FIG. NO.</u>	<u>ITEM NO.</u>	<u>NATIONAL STOCK NUMBER</u>	<u>FIG. NO.</u>	<u>ITEM NO.</u>
5905-00-135-3973	2	290	5905-00-509-4836	2	340
5905-00-135-3975	2	344	5905-00-577-3993	2	224
5905-00-136-8338	2	288	5905-00-650-9808	2	279
5905-00-141-0595	2	368	5905-00-900-0431	2	142
5905-00-141-0599	2	300	5905-00-910-9485	2	385
5905-00-141-0600	2	401	5905-00-910-9486	2	341
5905-00-141-0716	2	352	5905-00-935-8543	2	359
5905-00-141-0717	2	303	5905-00-935-8544	2	306
5905-00-141-0742	2	80	5905-00-935-8545	2	216
5905-00-141-0744	2	283	5905-00-952-0749	2	94
5905-00-141-1071	2	240	5905-00-957-9784	2	143
5905-00-141-1116	2	337	5905-00-984-6566	2	308
5905-00-141-1118	2	358	5910-00-044-4355	2	118
5905-00-141-1165	2	338	5910-00-051-4612	2	115
5905-00-141-1168	2	230	5910-00-064-4626	2	66
5905-00-141-1183	2	346	5910-00-067-5697	2	407
5905-00-171-1976	2	301	5910-00-068-1332	2	392
5905-00-185-8516	2	214	5910-00-068-1334	2	260
5905-00-195-6754	2	365	5910-00-069-1295	3	11
5905-00-228-6084	2	395	5910-00-080-9560	2	220
5905-00-244-8258	2	258	5910-00-085-0825	2	327
5905-00-246-8695	2	379	5910-00-088-1245	2	251
5905-00-247-8733	2	354	5910-00-088-2026	2	183
5905-00-249-3663	2	298	5910-00-088-3869	2	186
5905-00-252-1671	2	309	5910-00-089-3496	2	105
5905-00-279-2527	2	335	5910-00-089-3496	2	105
5905-00-279-2675	2	317	5910-00-195-5367	3	9
5905-00-345-6298	2	342	5910-00-542-7369	2	320
5905-00-369-6929	2	357	5910-00-543-9552	3	12
5905-00-400-4482	2	244	5910-00-556-1425	2	154
5905-00-421-0623	2	386	5910-00-649-5094	2	104
5905-00-435-6374	2	314	5910-00-655-0591	2	263
5905-00-434-2023	2	399	5910-00-666-5331	3	7
5905-00-485-4545	2	350			

SECTION IV. NATIONAL STOCK NUMBER AND PART NUMBER INDEX (CONTINUED)

<u>NATIONAL STOCK NUMBER</u>	<u>FIG. NO.</u>	<u>ITEM NO.</u>	<u>NATIONAL STOCK NUMBER</u>	<u>FIG. NO.</u>	<u>ITEM NO.</u>
5910-00-666-7992	2	109	5910-00-936-7405	2	324
5910-00-702-8057	2	108	5910-00-950-4810	2	363
5910-00-732-2210	2	114	5910-00-950-4811	2	404
5910-00-764-9574	2	113	5910-00-952-7046	2	111
5910-00-764-9574	2	250	5910-00-954-5496	2	101
5910-00-784-0696	2	241	5910-00-954-5498	2	321
5910-00-794-9064	2	99	5910-00-954-5508	2	110
5910-00-797-4909	2	375	5910-00-954-5508	2	116
5910-00-804-7088	2	380	5910-00-957-2054	2	221
5910-00-804-7566	2	394	5910-00-957-2054	2	405
5910-00-805-6630	2	390	5910-00-957-8578	2	406
5910-00-807-1539	2	242	5910-00-957-9908	2	269
5910-00-809-5484	2	295	5910-00-984-7588	2	212
5910-00-821-5215	2	318	5910-00-984-8678	2	91
5910-00-822-5233	3	21	5910-00-985-3870	2	78
5910-00-822-5683	2	34	5910-00-995-0614	2	107
5910-00-823-1068	2	315	5915-00-995-0614	2	311
5910-00-825-0403	2	227	5915-00-997-5399	2	349
5910-00-835-1200	2	355	5915-00-087-4928	2	245
5910-00-838-9421	2	153	5915-00-088-0814	2	199
5910-00-871-5935	2	102	5915-00-950-3454	2	397
5910-00-879-4513	3	8	5930-00-740-8600	2	81
5910-00-892-7334	2	391	5930-00-759-5150	2	277
5910-00-893-0196	2	233	5930-00-759-5151	2	249
5910-00-902-0335	2	236	5930-00-856-6277	2	333
5910-00-902-0335	2	237	5930-00-856-6278	2	21
5910-00-921-0403	2	106	5930-00-856-6392	2	271
5910-00-929-7374	2	228	5930-00-856-6393	2	86
5910-00-933-4005	2	299	5930-00-977-3468	2	75
5910-00-936-7372	2	248	5930-99-977-3469	2	74

SECTION IV. NATIONAL STOCK NUMBER AND PART NUMBER INDEX (CONTINUED)

<u>NATIONAL STOCK NUMBER</u>	<u>FIG. NO.</u>	<u>ITEM NO.</u>	<u>NATIONAL STOCK NUMBER</u>	<u>FIG. NO.</u>	<u>ITEM NO.</u>
5930-00-977-3470	2	234	5940-00-665-5764	2	112
5935-00-064-3839	2	136	5940-00-725-3240	2	400
5935-00-132-2405	2	49	5940-00-847-3138	2	43
5935-00-192-4729	2	19	5940-00-901-1405	2	383
5935-00-192-4753	1	4	5945-00-027-0721	2	374
5935-00-222-9828	2	46	5945-00-027-0723	2	372
5935-00-259-0337	2	41	5945-00-066-0661	2	381
5935-00-259-2034	2	64	5945-00-950-5572	2	70
5935-00-581-6941	2	59	5950-00-070-7637	2	219
5935-00-823-6962	2	369	5950-00-079-6045	2	389
5935-00-830-6348	2	373	5950-00-087-7300	2	262
5935-00-842-3858	2	50	5950-00-087-7301	2	278
5935-00-819-5758	2	16	5950-00-087-7317	2	206
5935-00-847-6803	2	31	5950-00-087-7318	2	198
5935-00-856-4005	1	5	5950-00-087-7324	2	181
5935-00-881-6538	2	140	5950-00-106-1273	2	264
5935-00-940-3165	2	384	5950-00-228-4234	2	209
5935-00-984-9532	2	119	5950-00-642-5951	2	189
5940-00-061-0050	2	48	5950-00-645-7431	2	388
5940-00-156-7344	2	53	5950-00-704-1993	2	304
5940-00-192-9962	2	69	5950-00-706-9463	2	213
5940-00-192-9962	2	100	5950-00-725-6103	2	155
5940-00-192-9962	2	252	5950-00-856-6153	2	232
5940-00-192-9962	2	387	5950-00-856-6275	2	96
5940-00-192-9962	2	398	5950-00-856-6283	2	76
5940-40-238-9758	2	231	5950-00-856-6284	2	90
5940-00-259-8457	2	88	5950-00-856-6285	2	377
5940-00-328-9758	3	26	5950-00-856-6369	2	77
5940-00-648-3092	2	71	5950-00-867-0940	2	85
5940-00-665-5592	2	93	5950-00-875-4595	2	253

SECTION IV. NATIONAL STOCK NUMBER AND PART NUMBER INDEX (CONTINUED)

<u>NATIONAL STOCK NUMBER</u>	<u>FIG. NO.</u>	<u>ITEM NO.</u>	<u>NATIONAL STOCK NUMBER</u>	<u>FIG. NO.</u>	<u>ITEM NO.</u>
5950-00-875-4596	2	229	5960-00-971-8432	3	2
5950-00-875-4597	2	393	5960-00-985-8987	2	30
5950-00-875-4598	2	396	5961-00-883-4798	2	366
5950-00-892-3453	2	129	5961-00-897-8326	2	280
5950-00-893-8650	2	289	5961-00-905-5083	2	302
5950-00-910-6361	3	23	5961-00-950-6606	3	17
5950-00-910-6367	3	27	5961-00-975-2175	2	225
5950-00-910-6380	3	15	5975-00-901-4348	1	6
5950-00-964-7450	2	378	6210-00-075-2502	2	210
5950-00-994-6600	2	226	6240-00-155-8706	2	149
5955-00-088-1995	2	128	6250-00-233-5086	2	150
5955-00-860-1245	2	24	6625-00-990-2475	2	15
5955-00-901-1991	2	123			
5955-00-901-1993	2	125			
5955-00-901-1994	2	126			
5955-00-901-1995	2	122			
5955-00-901-1998	2	133			
5955-00-901-2000	2	132			
5955-00-901-2947	2	130			
5955-00-901-2948	2	131			
5955-00-978-6349	2	331			
5955-00-984-9535	2	332			
5960-00-179-4446	2	29			
5960-00-302-5754	2	56			
5960-00-615-0243	2	202			
5996-00-971-8432	2	25			
5960-00-854-8467	2	26			
5960-00-854-8468	2	28			
5960-00-856-8336	2	201			
5960-00-860-7710	2	57			
5960-00-879-8174	2	27			
5960-00-860-7709	2	58			

SECTION IV. NATIONAL STOCK NUMBER AND PART NUMBER INDEX (CONTINUED)

<u>PART NUMBER</u>	<u>FSCM</u>	<u>FIG. NO.</u>	<u>ITEM NO.</u>	<u>PART NUMBER</u>	<u>FSCM</u>	<u>FIG. NO.</u>	<u>ITEM NO.</u>
A238-5MILL6085A	70417	2	160	CM06FD511J03	81349	2	269
BA811-2798	71590	2	413	DM15CI00K500WV4CR	72136	2	237
BA811-2896	71590	2	84	DM15C120K500WV4CR	72136	2	248
BA812-1211	71590	2	87	DM15C150K500WV4CR	72136	2	324
BL289-1424-000	71034	2	24	DM15E201FD300WV4CR	72136	3	11
BL290-8705-000	71034	2	331	DM15E330K500WV4CR	72136	2	221
BL290-8706-000	71034	2	332	DM15E510K500WV4CR	72136	2	105
CC20CH060D	81349	2	242	DM15E560K500WV4CR	72136	2	111
CC20CJ030D	81349	2	263	DM15EI01K500WV4CR	72136	2	212
CC20CK010C	81349	2	390	DM15F121K500WV4CR	72136	2	117
CK61AW222M	81349	2	391	DM15F221K500WV4CR	72136	2	311
CM04FD111G03	81349	2	233	DM15F471J300WWCR	72136	2	349
CM05CDI00D03	81349	2	236	DP234-258	21242	2	400
CM05ED200J03	81349	2	101	D205F102F	00853	2	10
CM05ED204J03	81349	2	406	D250F302F	00853	2	22
CM05ED220J03	81349	2	115	D28121	56289	2	363
CM05ED270J03	81349	2	407	D29343	56289	2	404
CM05ED330J03	81349	2	405	D29413	56289	2	78
CM05ED390J03	81349	2	392	D31582	56289	2	320
CM05ED430J03	81349	2	260	FA4000	07263	2	302
CM05ED470J03	81349	2	118	G2619	21242	2	383
CM05FD131J03	81349	2	114	HM6821	01121	2	308
CM05FD181J03	81349	2	321	KR25651	77342	2	70
CM05FD221J03	81349	2	107	LP9A1E683K	01884	2	297
CM05FD241G03	81349	2	110	LT4K039	81349	2	378
CM05FD241J03	81349	2	116	MS15571-2	96906	2	149
CM05FD271J03	81349	2	251	MS16624-1025	96906	2	419
CM05FD331G03	81349	2	108	MS35333-69	96906	2	178
CM05FD361G03	81349	2	113	MS35335-29	96906	2	44
CM05FD361J03	81349	2	250	MS35338-96	96906	2	276

SECTION IV. NATIONAL STOCK NUMBER AND PART NUMBER INDEX (CONTINUED)

<u>PART NUMBER</u>	<u>FSCM</u>	<u>FIG. NO.</u>	<u>ITEM NO.</u>	<u>PART NUMBER</u>	<u>FSCM</u>	<u>FIG. NO.</u>	<u>ITEM NO.</u>
MS35338-97	96906	2	97	P313-0149-000	77250	2	92
MS35338-98	96906	2	54	P313-0050-000	77250	2	60
MS35338-98	96906	3	5	P313-0051-000	77250	2	45
MS35649-244	96906	2	139	P313-0053-000	77250	3	4
MS35649-284	96906	2	167	P313-0132-000	77250	2	82
MS51957-17	96906	2	328	P313-0140-000	77250	2	51
MS51957-49	96906	2	165	P313-0156-000	77250	3	13
MS51959-16	96906	2	4	P325-0062-000	77250	2	187
MS51959-17	96906	2	270	P330-2292-000	77250	2	137
MS51959-18	96906	2	121	P334-0253-000	77250	2	95
MS51959-28	96906	2	284	P334-4060-000	77250	2	22
MS75008-40	96906	2	304	P342-0147-000	77250	2	61
MS75089-15	96906	2	336	P342-0168-000	77250	1	7
MS90538-20	96906	2	226	P343-0282-000	77250	2	411
MS90539-15	96906	2	289	P343-0284-000	77250	2	89
MS90540-07	96906	2	219	P343-0285-000	77250	2	42
M24251-6-2	81349	2	58	P343-0285-000	77250	3	14
M2451-6-5	81349	2	57	P343-0286-000	77250	2	47
M2451-6-6	81349	2	201	P343-0287-000	77250	3	19
M641-5-1	81349	2	19	P343-0291-000	77250	2	161
N020BRASS	08591	2	17	P343-0297-000	77250	2	177
PD52313	72136	2	67	P343-0298-000	77250	2	179
PD52414	72136	2	66	P343-0300-000	77250	2	370
PD068	81349	1	4	P343-0302-000	77250	2	274
PV3	06915	2	273	P343-0307-000	77250	2	207
PW5-6001-10	07716	2	296	P343-0328-000	77250	2	72
PW7-15000-10PCT	07716	2	385	P343-0329-000	77250	2	52
				RCR07G101KS	81349	2	346
P319-0043-000	77250	2	147	RCR07G103KS	81349	2	254
P313-0061-000	77250	2	36	RCR07G104KS	81349	2	223

SECTION IV. NATIONAL STOCK NUMBER AND PART NUMBER INDEX (CONTINUED)

<u>PART NUMBER</u>	<u>FSCM</u>	<u>FIG NO</u>	<u>ITEM NO.</u>	<u>PART NUMBER</u>	<u>FSCM</u>	<u>FIG. NO.</u>	<u>ITEM NO.</u>
RCR07G105KS	81349	2	211	RCR20G102KS	81349	2	79
RCR07G121KS	81349	2	347	RCR20G104KS	81349	2	267
RCR07G151KS	81349	2	348	RCR20G104KS	81349	3	16
RCR07G155JS	81349	2	286	RCR20G105JS	81349	2	265
RCR07G181KS	81349	2	80	RCR20G120JS	81349	2	386
RCR07G221KS	81349	2	290	RCR20G121KS	81349	2	218
RCR07G225KS	81349	2	309	RCR20G123KS	81349	2	217
RCR07G271KS	81349	2	291	RCR20G124KS	81349	2	266
RCR07G272KS	81349	2	282	RCR20G151KS	81349	2	145
RCR07G273KS	81349	2	351	RCR20G152KS	81349	2	238
RCR07G331KS	81349	2	292	RCR20G153KS	81349	2	264
RCR07G334KS	81349	2	350	RCR20G155JS	81349	2	326
RCR07G335JS	81349	2	310	RCR20G181KS	81349	2	306
RCR07G360KS	81349	2	343	RCR20G183KS	81349	2	216
RCR07G391KS	81349	2	294	RCR20G184KS	81349	2	312
RCR07G470KS	81349	2	330	RCR20G220KS	81349	2	362
RCR07G471KS	81349	2	293	RCR20G221JS	81349	2	257
RCR07G472KS	81349	2	281	RCR20G222KS	81349	2	230
RCR07G473KS	81349	2	303	RCR20G224KS	81349	2	268
RCR07G474KS	81349	2	222	RCR20G270KS	81349	2	360
RCR07G560KS	81349	2	256	RCR20G273KS	81349	2	325
RCR07G562KS	81349	2	283	RCR20G274JS	81349	2	239
RCR07G680KS	81349	2	344	RCR20G330KS	81349	2	359
RCR07G682KS	81349	2	243	RCR20G331KS	81349	2	307
RCR07G684KS	81349	2	224	RCR20G332KS	81349	2	403
RCR07G820KS	81349	2	345	RCR20G333KS	81349	2	259
RCR07G823KS	81349	2	314	RCR20G390KS	81349	2	358
RCR07G825KS	81349	2	287	RCR20G392KS	81349	2	402
RCR20G100KS	81349	2	313	RCR20G393KS	81349	2	300
RCR20G101KS	81349	2	235	RCR20G470KS	81349	2	322

SECTION IV. NATIONAL STOCK NUMBER AND PART NUMBER INDEX (CONTINUED)

<u>PART NUMBER</u>	<u>FSCM</u>	<u>FIG. NO.</u>	<u>ITEM NO.</u>	<u>PART NUMBER</u>	<u>FSCM</u>	<u>FIG. NO.</u>	<u>ITEM NO.</u>
RCR20G472KS	81349	2	368	RCR42G153KS	81349	2	316
RCR20G473KS	81349	2	142	RCR42G183KS	81349	2	288
RCR20G474KS	81349	2	240	RCR42G220KS	81349	2	342
RCR20G560KS	81349	2	261	RCR42G223KS	81349	2	335
RCR20G562KS	81349	2	337	RCR42G273KS	81349	2	340
RCR20G624JS	81349	2	364	RCR42G333KS	81349	2	317
RCR20G680KS	81349	2	352	RCR42G473KS	81349	2	365
RCR20G681KS	81349	2	23	RCR42G682JS	81349	2	279
RCR20G682KS	81349	2	338	RCR42G683KS	81349	2	298
RCR20G683KS	81349	2	246	RCR42G821KS	81349	2	399
RCR20G684KS	81349	2	376	RTMT12M	91663	2	88
RCR20G820KS	81349	2	361	RTMT16M	91663	2	48
RCR20G821KS	81349	2	353	RT718FRC93	80058	1	1
RCR20G822KS	81349	2	401	R3472X5-32CADPL	12014	2	65
RCR20G823JS	81349	3	24	SK10066	72982	2	99
RCR20G823KS	81349	2	339	ST1050-34	95238	2	112
RCR32G100KS	81349	2	323	TC10-30	09052	3	9
RCR32G104KS	81349	2	305	TC100-67	09052	3	8
RCR32G123JS	81349	2	395	TC20-90	09052	3	7
RCR32G153KS	81349	2	334	TC65	37942	2	327
RCR32G222KS	81349	2	255	TS0205C01	81349	2	59
RCR32G332KS	81349	2	258	TS102P01	81349	2	49
RCR32G333JS	81349	2	244	TS103P01	81349	2	46
RCR32G472KS	81349	2	356				
RCR32G473KS	81349	2	357	T163X97	02288	2	372
RCR32G474JS	81349	2	204	T50411	72136	2	152
RCR32G562JS	81349	2	354	VVC445	16352	2	247
RCR32G680KS	81349	2	379	WR5451	71450	2	144
RCR42G103KS	81349	2	214	WR5453	71450	2	94
RCR42G123KS	81349	2	301	WR5454	71450	2	143

SECTION IV. NATIONAL STOCK NUMBER AND PART NUMBER INDEX (CONTINUED)

<u>PART NUMBER</u>	<u>FSCM</u>	<u>FIG. NO.</u>	<u>ITEM NO.</u>	<u>PART NUMBER</u>	<u>FSCM</u>	<u>FIG. NO.</u>	<u>ITEM NO.</u>
WW19491	10630	2	420	192796CK	76854	2	277
X004	81815	2	77	1966302FIAC	76854	2	21
X006-1	81815	3	27	196305CK	76854	2	249
X083	81815	2	76	197029K4	76854	2	333
X094-1	81815	2	90	2AIDB15	92825	2	231
X239	81815	2	96	2A1DB15	92825	3	26
X682-1	81815	2	85	2DDD63G104XAA	71590	2	227
1-8SSBALL	27545	2	170	2DDH63N103M	71590	2	380
1N1490	81483	2	366	20C109	56289	3	21
1N34A	03877	2	280	201-11-01-018	71785	2	64
1N4454	03508	3	17	2104-04 -01-2520N	78189	2	43
1N458	07263	2	225	2104-06-02-2520N	78189	2	53
10200-129	06560	3	23	22-16-3	81073	2	384
114-22-12-018	71785	3	25	2262-414LW1	82104	2	271
12AT7	86684	2	29	22698-6MLW	82104	2	81
1214-05	78189	2	32	240-0186-000	06560	2	389
13A	82389	2	16	240-0194-000	06560	2	189
1400W	72512	2	20	281-0330-000	18986	2	5
1520A	71785	2	387	288-2509-000	13499	2	181
1529A	71785	2	69	290-9009-000	32897	2	123
1532A	71785	2	398	290-9010-000	32897	2	124
1545D	71785	2	319	290-9011-000	32897	2	125
160-104-3	71313	2	98	290-9027-000	32897	2	126
168-013-1000	02660	2	50	290-9028-000	32897	2	122
1704-03	78189	2	148	290-9062-000	32897	2	127
1712-00	78189	2	68	290-9063-000	13499	2	128
1720-02	78189	2	18	290-9066-000	32897	2	132
18-257	09250	2	155	290-9097-000	32897	2	133
19C372	56289	2	318	290-9098-000	32897	2	129
191774-23	76854	2	86	290-9099-000	32897	2	130

SECTION IV. NATIONAL STOCK NUMBER AND PART NUMBER INDEX (CONTINUED)

<u>PART NUMBER</u>	<u>FSM</u>	<u>FIG NO.</u>	<u>ITEM NO.</u>	<u>PART NUMBER</u>	<u>FSCM</u>	<u>FIG. NO.</u>	<u>ITEM NO.</u>
290-9201-000	32897	2	131	330-0733-000	45722	2	163
30040-2	02288	2	382	330-0735-000	45722	2	157
30040-3	02288	2	381	331-5020-000	79807	2	421
3055-2	02288	2	373	331-7000-000	79807	2	415
30055-20	02288	2	369	33103X5U0501K	72982	2	355
302-0023-000	05284	2	62	332-14-02-001	71785	2	100
302-0030-000	05284	2	208	332-1403-165	71785	2	252
303-3030-000	79807	2	73	335-0041-000	08664	1	3
309-5300-000	27545	2	173	34103	76487	2	209
310-0007-000	79807	2	285	3501FP	82389	2	31
310-0045-000	79807	2	329	3501MC	82389	1	5
310-0053-000	79807	2	63	36C175A	56289	2	34
310-0054-000	79807	2	184	376-7202-000	71450	2	141
310-0055-000	79807	2	188	376-7206-000	71450	2	35
310-0056-000	79807	3	6	37859	73386	2	377
310-0061-000	79807	2	40	39003	76487	2	194
310-0278-000	70318	2	83	40C73A1	56289	2	153
310-0278-000	70318	3	20	4012HT	77147	2	93
310-6320-000	79807	2	371	41C92	56289	2	241
310-0156-000	77250	2	180	4159-043	72765	2	150
327-029X5T0102Z	72982	2	394	432-1009-000	94452	2	193
327029H3M0102K	72982	2	91	44C7A	56289	2	315
328-0005-000	08664	2	10	4422-10-38	06560	2	213
328-0028-000	08664	2	17	458-0491-000	13499	2	15
328-0473-000	08664	2	12	5C11A	56289	2	299
328-0506-020	08664	2	14	5C13A	56289	2	295
328-0512-010	08664	2	191	500-1073-003	13499	2	162
33C2	56289	2	154	502-1427-002	13499	2	56
33C58	56289	2	375	503-1236-001	13499	2	275
330-0731-000	45722	2	103	506-7848-002	13499	2	71

SECTION IV. NATIONAL STOCK NUMBER AND PART NUMBER INDEX (CONTINUED)

<u>PART NUMBER</u>	<u>FSCM</u>	<u>FIG. NO.</u>	<u>ITEM NO.</u>	<u>PART NUMBER</u>	<u>FSCM</u>	<u>FIG. NO.</u>	<u>ITEM NO.</u>
5100-25C	79136	2	39	544-2825-002	13499	2	119
515-0325	72619	2	210	544-3125-002	13499	2	199
522-1093-000	13499	2	423	544-3132-002	13499	2	272
522-1093-000	13499	3	1	544-3139-002	13499	2	182
526-9427-000	13499	2	151	544-3146-003	13499	2	192
540-9045-003	13499	2	120	544-7262-000	13499	2	408
540-9049-003	13499	2	422	544-7268-002	13499	2	13
540-9053-003	13499	2	146	544-9695-000	13499	2	37
540-9448-003	13499	2	367	544-9698-000	13499	2	245
542-5476-002	13499	2	55	544-9699-000	13499	2	396
543-7322-000	13499	3	18	544-9700-000	13499	2	393
543-7323-000	13499	3	15	544-9701-000	13499	2	198
543-7329-002	13499	3	3	544-9705-002	13499	2	159
543-7739-000	13499	2	190	544-9706-002	13499	2	196
543-8024-000	13499	2	206	544-9707-002	13499	2	197
543-8028-002	13499	2	232	544-9709-002	13499	2	38
543-8030-000	13499	2	168	544-9711-002	13499	2	134
543-8034-000	13499	2	417	544-9715-002	13499	2	262
543-8039-000	13499	2	6	544-9719-003	13499	2	183
543-8042-000	13499	2	414	544-9720-003	13499	2	158
543-8043-000	13499	2	7	544-9721-003	13499	2	169
543-8044-000	13499	2	8	544-9722-003	13499	2	175
543-8062-002	13499	2	156	544-9745-005	13499	1	6
543-8065-002	13499	2	166	545-6000-002	13499	2	410
543-8078-002	13499	2	9	545-6002-002	13499	2	409
543-8087-002	13499	2	164	545-9114-000	13499	2	1
543-8088-002	13499	2	412	546-2130-002	13499	2	174
543-8103-002	13499	2	176	546-7829-004	13499	2	135
543-8123-002	13499	2	229	546-7833-002	13499	2	253
544-0779-004	13499	2	11	546-7945-003	13499	2	278

SECTION IV. NATIONAL STOCK NUMBER AND PART NUMBER INDEX (CONTINUED)

<u>PART NUMBER</u>	<u>FSCM</u>	<u>FIG. NO.</u>	<u>ITEM NO.</u>	<u>PART NUMBER</u>	<u>FSCM</u>	<u>FIG. NO.</u>	<u>ITEM NO.</u>
546-8005-002	13499	2	138	86CP11-1008	02660	2	136
548-8217-000	13499	2	397	86CP9-1003	02660	2	140
548-9326-000	13499	2	416	88128CK	76854	2	75
553-5787-003	13499	1	2	88130CK	76854	2	74
557-018-1-5-7A	72982	2	104	88216CK	76854	2	234
557-018A3-0-12PF	72982	2	109	8947-151	04009	2	418
557-018-5-25A	72982	3	12	913-3829-000	71590	2	220
557006C0P039R	72982	2	102	920-0138-000	80486	2	186
557006U2P034R	72982	2	106	9348	24226	2	388
59-412-1000	02660	2	41	9404-11-20026	71313	2	185
6SPLINE416S	08664	2	195	97NM02	72962	2	172
6AZ8	49671	2	28	970-2439-010	02288	2	374
<u>NATIONAL STOCK NUMBER ASSIGNMENTS</u>							
6BN8	82219	2	26	5325-00-017-6972		1	8
6CL6	86684	2	202	5355-00-971-0590		2	8
6DC6	02735	2	30	5910-00-794-9073		2	98
6EB8	82219	2	27	5910-00-828-3291		3	10
6H12	82893	2	215	3020-01-017-6973		2	409
6U8A	81349	2	25	5905-01-026-2157		2	144
609-1215-001	13499	2	33	5910-01-026-2170		3	22
6146B	94998	2	200	5910-01-026-2180		2	203
628-0774-001	13499	1	8	5915-01-016-8275		2	151
710-9000-00	13499	2	341	5935-01-026-2200		3	25
7543	86684	3	2	5940-01-026-9164		2	319
757-8613-001	13499	2	3	5950-01-022-0501		2	336
757-8614-001	13499	2	2				
82-11-180-16	94222	1	9				
82-31-293-15	75618	1	10				
820-0171-000	13499	BULK					
825-213X5V0104Z	72982	2	228				
854-15N	13499	2	203				
858W5T2KV1KPPFORM20PCT	72982	2	205				

By Order of the Secretary of the Army:

Official:

J.C. PENNINGTON
Brigadier General, United States Army
The Adjutant General

BERNARD W. ROGERS
General, United States Army
Chief of Staff

Distribution:

To be distributed in accordance with DA Form 12-50, Direct and General Support maintenance requirements for AN/FRC-93.

I

RECOMMENDED CHANGES TO EQUIPMENT TECHNICAL PUBLICATIONS



THEN...JOT DOWN THE
DOPE ABOUT IT ON THIS FORM.
CAREFULLY TEAR IT OUT, FOLD IT
AND DROP IT IN THE MAIL.

SOMETHING WRONG WITH PUBLICATION

FROM: (PRINT YOUR UNIT'S COMPLETE ADDRESS)

DATE SENT

PUBLICATION NUMBER

PUBLICATION DATE

PUBLICATION TITLE

BE EXACT PIN-POINT WHERE IT IS

PAGE
NO.

PARA-
GRAPH

FIGURE
NO.

TABLE
NO.

IN THIS SPACE, TELL WHAT IS WRONG
AND WHAT SHOULD BE DONE ABOUT IT.

TEAR ALONG PERFORATED LINE

PRINTED NAME, GRADE OR TITLE AND TELEPHONE NUMBER

SIGN HERE